

# ARGAL

CHEMICAL PUMPS

***ZGE solid non-metallic centrifugal pumps***

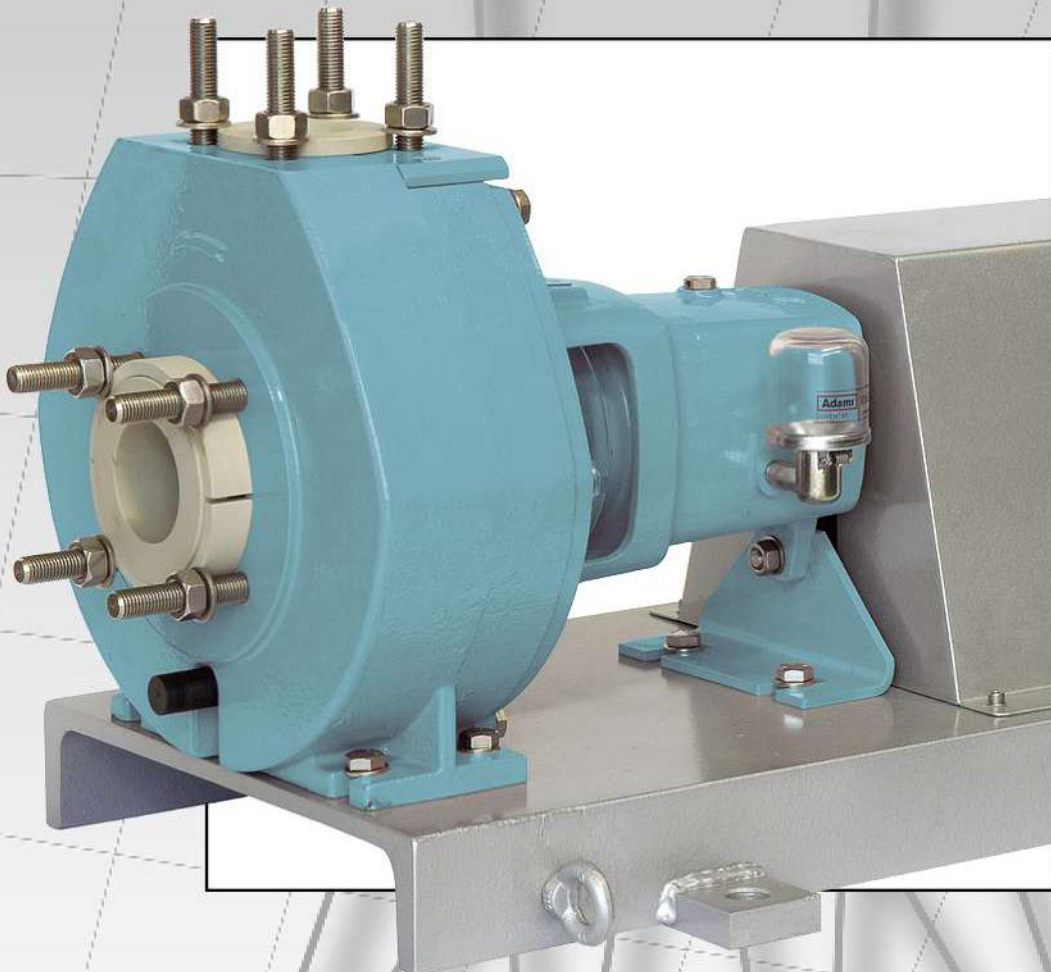

***IN COMPLIANT TO ISO 2858***

## ARGAL chemical pumps Quality, Experience, Innovation.

### THE COMPANY

Established as supplier of the galvanic industry the Company ARGAL has been designing and manufacturing pumps in thermoplastic polymers for more than 30 years.

The products turned out to be the best solution for universal resistance of plastic material against chemical aggressive agents without using special alloys that are very expensive.

The Company offers a wide range of pumps in many executions for industrial applications where temperature from -40 °C to 120 °C with flow up to 1000 mc/h and head more than 100 m are required.

The Company's strategy, concerning the project and the process of production, is closely oriented to research and rigorous quality in order to achieve absolute confidence in the products reliability. The ISO 9001:2000 certificate, obtained in 2002, shows the validity of organizational procedures, the suitability of operative instruments either from design level (using parametric CAD, mechanical analysis GEM and CFD for fluid-dynamic evaluation) and from productive level (numerical control machines, well-equipped assembling department, modern test room).

The whole process is run by professionals.

### THE SERVICES

Regarding the services a new impulse to the expansion comes from the facilities in Brescia where the headquarter's wide spaces – 4000 sqm. plus other 500 sqm. are devoted to all the activities.

The web site [www.argal.it](http://www.argal.it) has been set up with all the necessary informations. One can download graphics, infos, data. With a password is possible to download many technical details, too. The system INTRASET allows the clients to make their choice on line, helping them find the right pump.

In order to meet our customer's needs we offer the following services:

- pre-sale assistance defining the application details
- post-sale technical assistance service run by experts
- kit-service assistance to supply all spare parts available in stock.



### ARGAL CHEMICAL PUMPS (DALIAN) Co. Ltd.

In the process of internationalization ARGAL has established, in march 2004, a subsidiary Company in Dalian - China, to better support the chinese market.

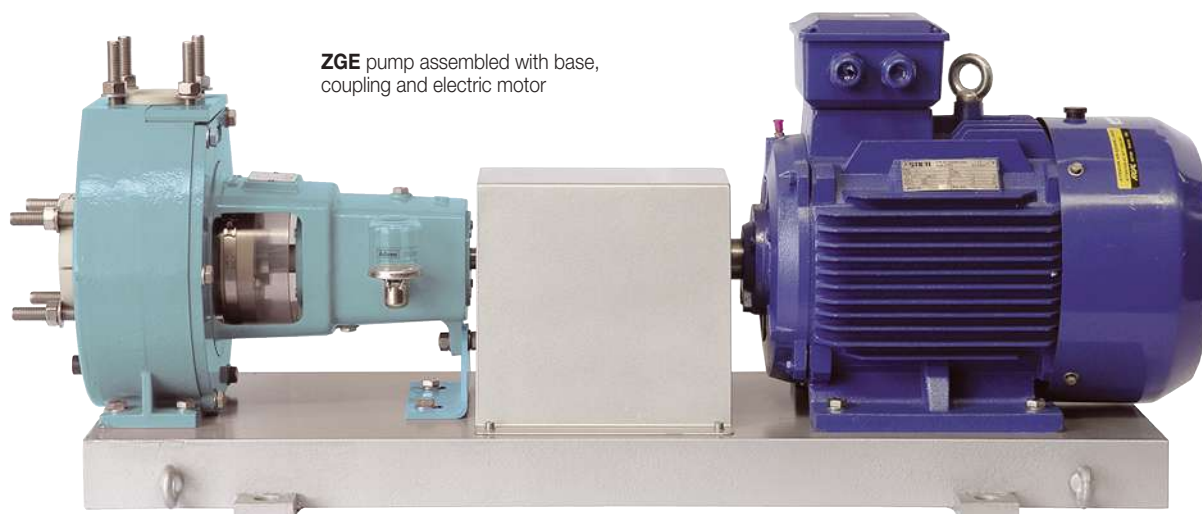

ZGE pump assembled with base,  
coupling and electric motor

## MAIN FEATURES

ZGE pumps are a complete range of centrifugal chemical process pumps, built in compliance with ISO2858 (Din 24256 - BS5257 - NFE 44121).

Standardisation of performance points and above all, the main constructional dimensions of the pumps, bases, couplings and shaft seals offers great advantages in total interchangeability of pumps and their component parts.

## CONSTRUCTION

Centrifugal single impellers, with horizontal end suction and central top discharge. For maximum integrity pump bodies are machined from solid, with piping loads absorbed by the metal flanges of the volute casing. As "process" pumps they are designed to accept commercially available standardised mechanical seals. External, single or internal double with interseal flush can be installed (see choosing the right mechanical seal). The pump shaft is independently mounted in rolling element bearings designed to accept all dynamic loading from all operating conditions. The pumps are oil lubricated and are provided with a constant level oiler to ensure optimum performance.

Pumps and drivers are mounted on a common base with drive via flexible spacer couplings (Din 740) use of a spacer enables service of the pump without disconnecting pipework or removing motors (Fig. 1).

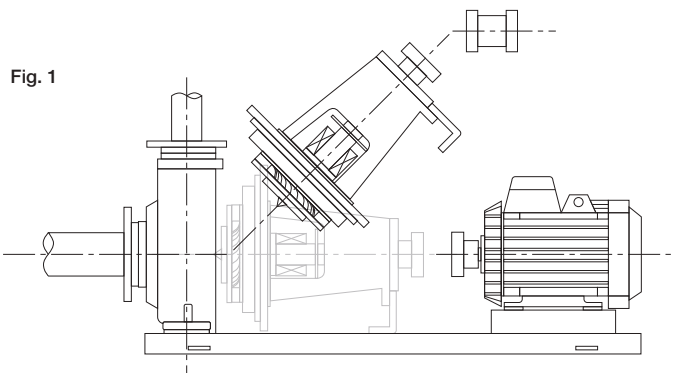

Fig. 1

## MATERIALS

The materials that come into direct contact with the chemicals are extremely resistant to them. The FC, WR, WF, ER and QR versions of the pump and the many different types of seal are different combinations of the materials that can be used for the pump parts coming into direct contact with the pumped fluid. A selection of the correct combination of materials ( by consulting the compatibility tables supplied by our customer service) involves rapidly examining the chemical composition of the liquid, its concentration and its temperature: doing this ensures that the most suitable pump will be chosen for a given application and that it will be operate within the required safety margins.

## MOTOR

Standard specification for motor is : IP55 enclosure, class F insulation, suitable - phase, suitable for 400V +/-5%, 50Hz (440V +/- 5% 60Hz). Other specifications are available on request to meet specific customer requirements.

## PAINTWORK

External metal surfaces are protected by an epoxy coating over an appropriate primer undercoat.

## QUALITY

The used materials are certified in the origin and in the composition. Upon request is available a final test according ISO 2548 Class C.

Spare parts undergo the same stringent inspection procedures to ensure complete inter-changeability (Fig. 2).



Fig. 2

## APPLICATIONS

THE RIGHT PUMP FOR THE RIGHT PROCESS.

ARGAL pumps are suitable for acid, hydroxide and salt solutions in varying concentrations and at various temperatures; mixture of strong acids; electrolytic baths; aromatic hydrocarbons; chlorides and alcohol.

## APPLICATION EXAMPLES

- Chemical and pharmaceutical processes.
- Petrochemical, chemical and agricultural engineering.
- Textile industries, dye treatments.
- Transfer, loading and distribution of chemical products.
- Surface treatments (coils and wire pickling and the dregreasing).
- Electro-plating treatments.
- Circulating pumps for heat exchangers in anodising industries.
- Waste water treatments.
- Scrubbing tower, antipollution plants.
- Fish farm water circulation.
- Thermal and sea water.
- Water purification.

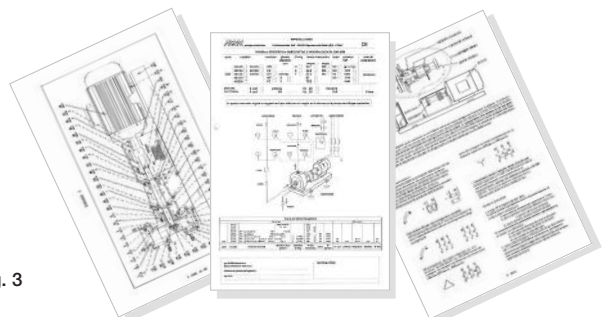
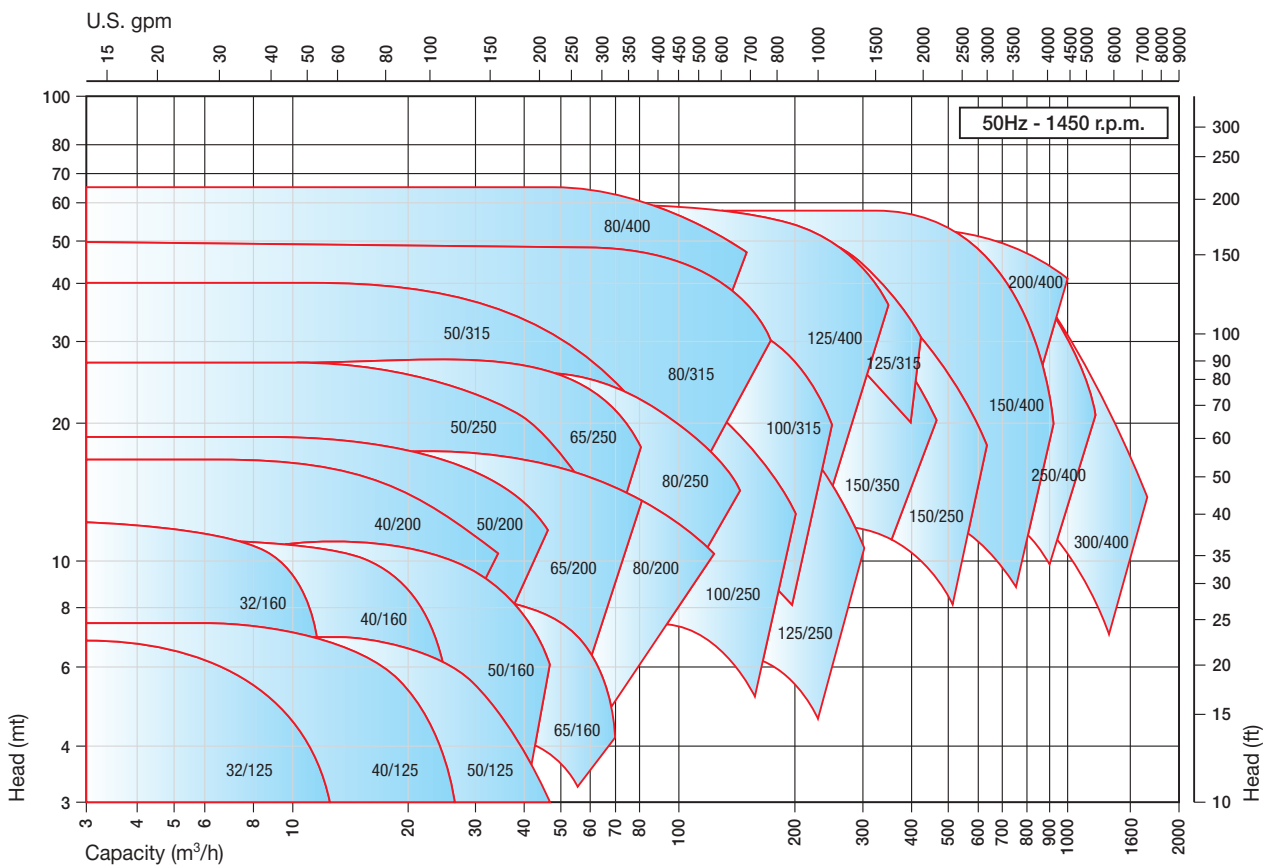
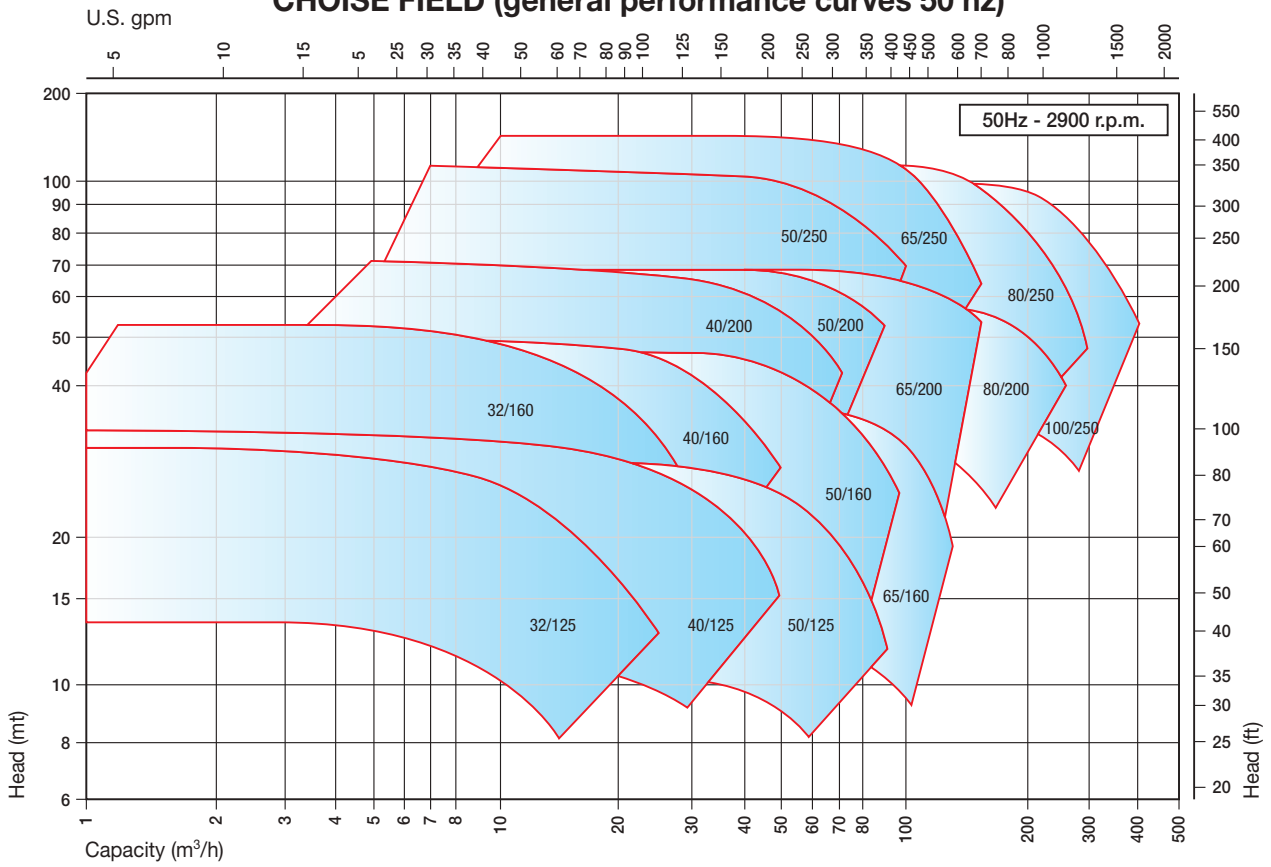

Fig. 3

## WARNING

ZGE pumps comply with EC standards on machine safety and are supplied complete with all the relevant documentation. The installation, operation and maintenance manual must be carefully read and scrupulously followed by the user (Fig. 3).

**CHOISE FIELD (general performance curves 50 hz)**



**NOTES:**

ARGAL performance curves are based upon water at 20° C. General performance curves for both 1450 and 2900 rpm are shown. These are based upon the maximum size of impeller available for each model. More detailed curves for both 1450 and 2900 rpm (see specific

curves) give the performance curves for each available impeller diameter. These also give NPSHr, Efficiency, and absorbed motor power. Liquid viscosities up to 40 cSt will not adversely affect pump performance.

**CHOISE FIELD (general performance curves 60 hz)**

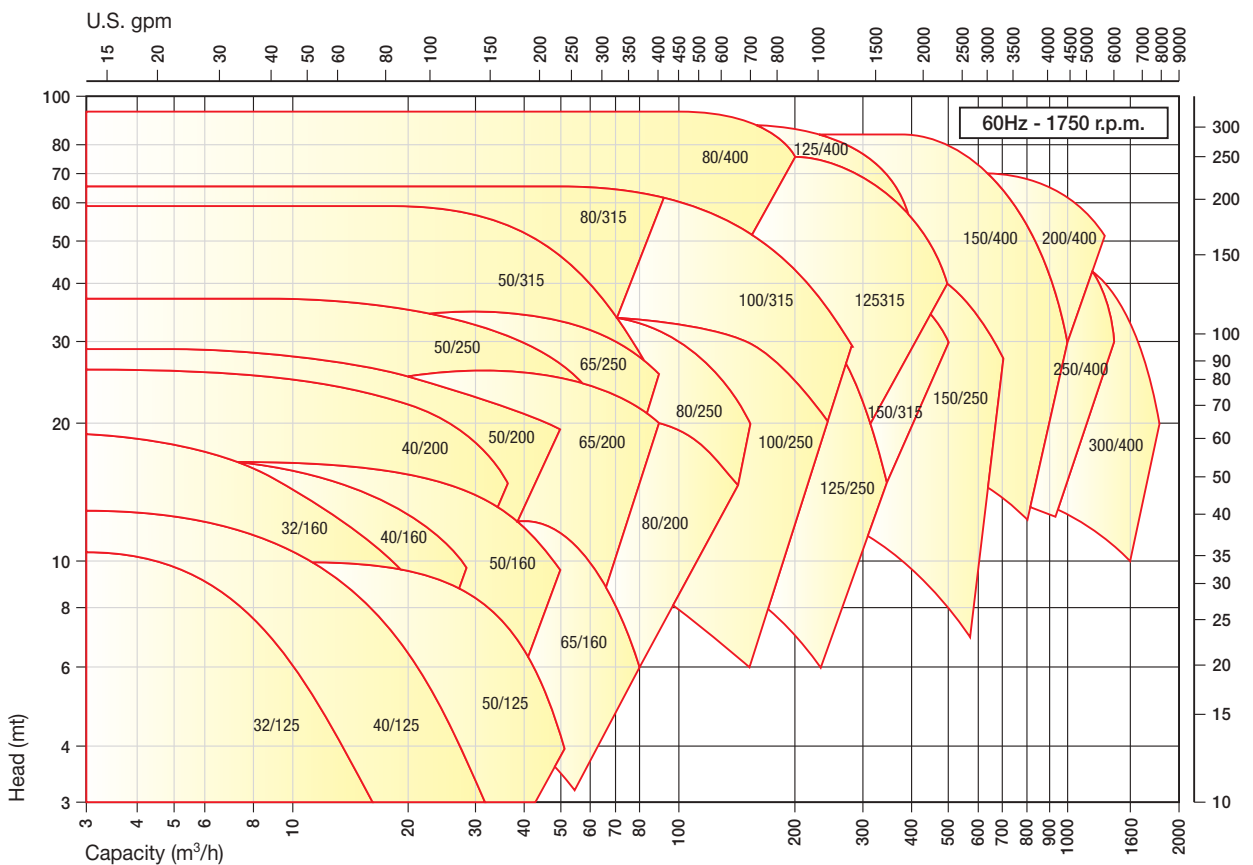
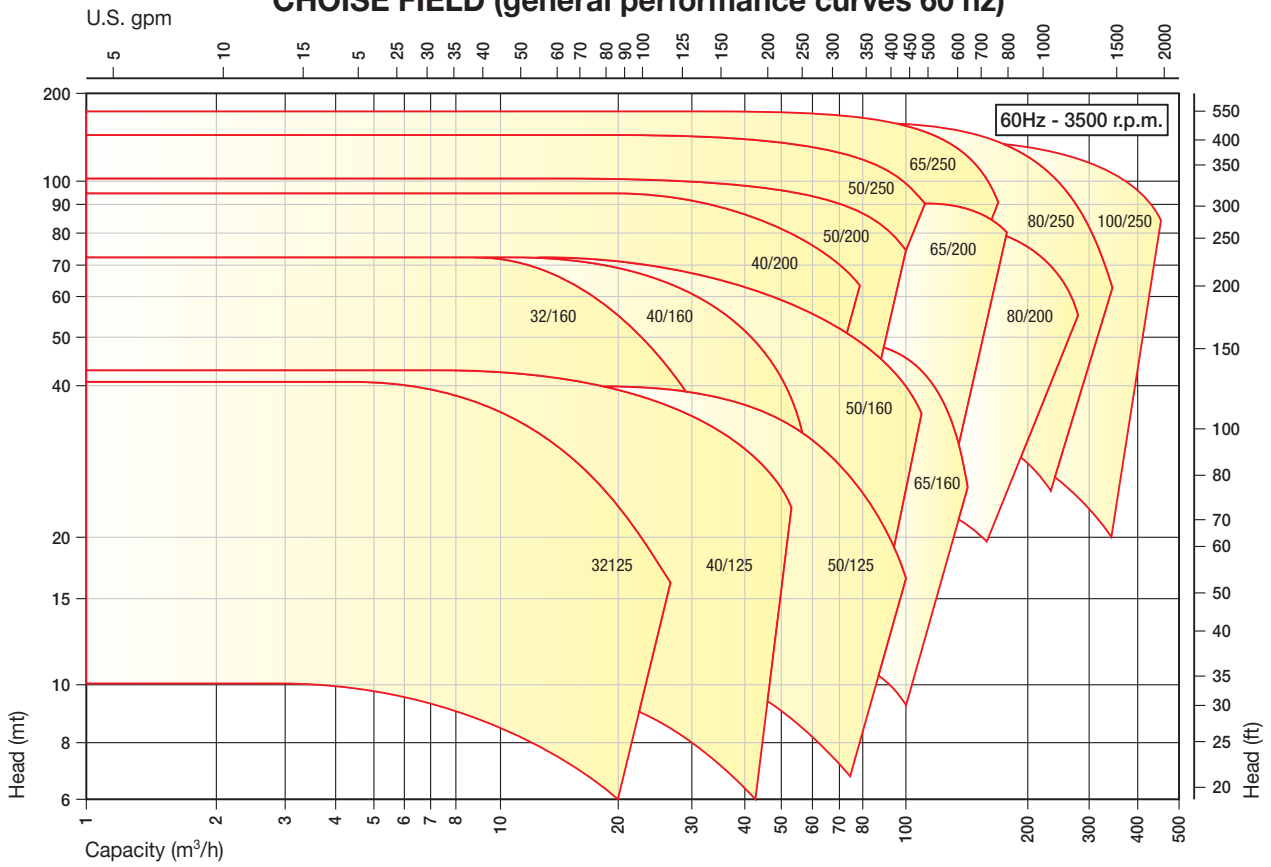

Pumps can operate on viscous liquids up to 120 cSt however impeller and pump modifications will be required. For hot liquids especially the NPSH (Net Positive Suction Head) must be considered. Suction pipework should be kept to a minimum, with as few

bends/restrictions as possible. The pipe diameter should be at least that of the pump inlet, with the fluid velocity as low as is practical. If you have any problems ARGAL Customer Services will be pleased to advise.

## THE MATERIALS

table 1

VERSION	FC	WR	WF	ER	QR
PUMP CASING	PVDF	PP	PP	PEHMW	PVC
IMPELLER	PVDF	PP	PVDF	PEHMW	PVC
PLATE	PVDF	PP	PP	PEHMW	PVC
SLEEVEN	PVDF	PP	PP	PEHMW	PVC
METAL FLANGES	CAST IRON				
SUPPORT	CAST IRON				
BASE	STEEL				
GASCHET	FKM				

- **FC:**

The base resin is PVDF (polyvinilidene fluoride): This is a fluorinated plastomer that is highly resistant to abrasion and has a high degree of mechanical resistance. If used in centrifugal pumps, it can withstand peaks of temperature of 120° C and can operate continuously at 100° C. It is extremely resistant to strong concentrated acids and has good resistance to organic solvents (except for Ketones, esters and acetone), extremely resistant to hot solutions of inorganic salts.

- **WR:**

The base resin is PP (polypropylene): very good mechanical resistance, good resistance to heat deformation. If used in centrifugal pumps, it withstands peak temperature up to 90° C; it operates continuously at 70° C. It is extremely resistant to high concentrations of weak acids and high alkaline concentrations. Good resistance to cold concentrations of strong acids, excellent resistance to solutions of inorganic salts.

- **WF:**

The base resin is PP (polypropylene): the parts that are subjected to particularly heavy duty are of PVDF in order to increase the pump resistance to wear and abrasion. It can operate continuously at temperatures of up to 85° C.

- **ER:**

The base resin is PeHMW (polyethylene high molecular weight): it has as high chemical resistance as PP and is also resistant to many organic solvents. It is more suitable for use at low temperatures (down to - 30° C) with an upper limit of +50° C for continuous use.

- **QR:**

The base resin is PVC (polyvinyl chloride): it has excellent resistance to alkaline solutions and acids (in particular, chromic acid, sulphur-nitrate mixtures, sulphuric acid, sodium hypochlorite, turpentine and ozone). The pump can be used at temperatures of up to 40° C.

Elastomers used:

- **E: EPDM**

ethylene-propylene rubber; high chemical resistance, not suitable for oils.

- **V: FKM**

fluorine based compound; high chemical resistance, including many solvents.

- **K: FFKM**

perfluoroelastomer, very high compatibility with many chemicals and excellent resistance to ageing.

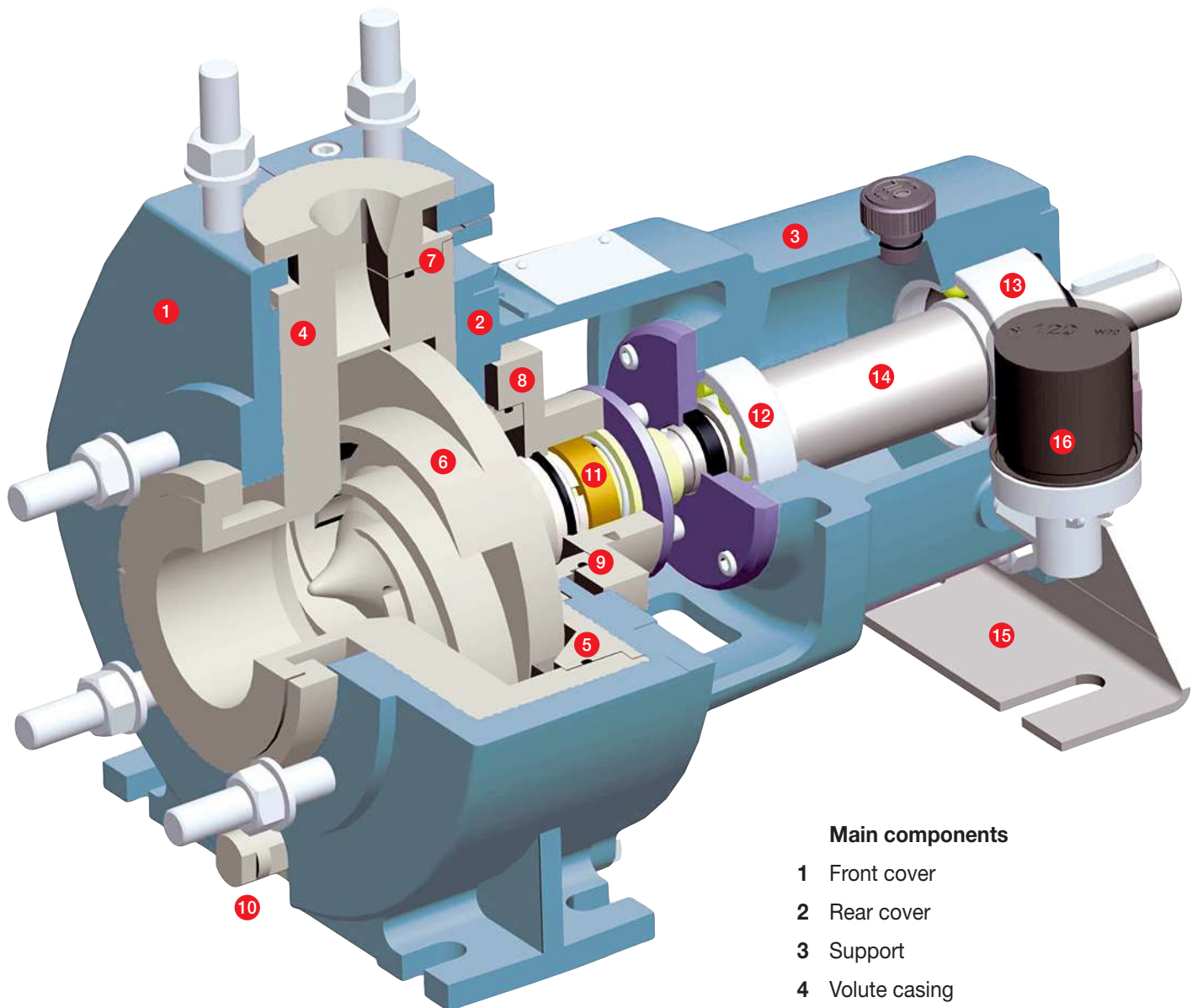

## SECTION VIEW

**Main components**

- 1 Front cover
- 2 Rear cover
- 3 Support
- 4 Volute casing
- 5 Intermediate plate
- 6 Impeller
- 7 O-ring
- 8 Seal chamber
- 9 O-ring
- 10 Drain plug
- 11 Mechanical seal
- 12 Bearing
- 13 Bearing
- 14 Shaft
- 15 Support foot
- 16 Bulb lubricator

## MECHANICAL SEALS

table 2

EXECUTION	SE1	SE3	B1	B3	TS2	TS3	M3	M4	M5	M9	M10
ROTATING PART	GFR-PTFE		SiC		Carbon	SiC	Carbon		SiC	SiC	SiC
FIXED RING	Al <sub>2</sub> O <sub>3</sub>		SiC		Al <sub>2</sub> O <sub>3</sub>				SiC	Al <sub>2</sub> O <sub>3</sub>	SiC
GASKET (Std)	/		FKM								

- **SE1**

Single, balanced external mechanical seal, with PTFE bellows. Rotating head: reinforced PTFE. Fixed ring: Ceramic (Al<sub>2</sub>O<sub>3</sub>). Manufacturer: ARGAL.

- **SE3**

Single, balanced external mechanical seal, with PTFE bellows. Rotating head: reinforced PTFE. Fixed ring: Ceramic (Al<sub>2</sub>O<sub>3</sub>). Manufacturer: CRANE (model 10T).

- **B1**

Single, balanced external mechanical seal, with O-ring seal. Rotating head and fixed ring: Silicon carbide (SiC); Manufacturer: PACIFIC (model Allpac 481).

- **B3**

Single, balanced external mechanical seal, with O-ring seal. Rotating head and fixed ring: Silicon carbide (SiC); Manufacturer: ARGAL.

- **TS2**

Single, balanced external mechanical seal, with elastomer bellows. Rotating head: Carbon. Fixed ring: Ceramic (Al<sub>2</sub>O<sub>3</sub>). Manufacturer: HUHNSEAL (model HNT).

- **TS3**

Single, balanced external mechanical seal, with elastomer bellows. Rotating head: Silicon carbide (SiC). Fixed head: (Al<sub>2</sub>O<sub>3</sub>). Manufacturer: HUHNSEAL (model HNT).

- **M3**

Double external mechanical seal, with PTFE sealing wedges, for external flush with compatible fluid. Rotating head: Carbon. Fixed rings: Ceramic (Al<sub>2</sub>O<sub>3</sub>). Manufacturer: CRANE (model 9T/9T).

- **M4**

Double external mechanical seal, with elastomer bellows, for external flush with compatible fluid. Rotating head: Carbon. Fixed rings: Ceramic (Al<sub>2</sub>O<sub>3</sub>). Manufacturer: CRANE (model 502/502).

- **M5**

Double external mechanical seal, with elastomer bellows, for external flush with compatible fluid. Rotating head: Silicon carbide (SiC). Fixed rings: Silicon carbide (SiC). Manufacturer: CRANE (model 502/502).

- **M9**

Double external mechanical seal, with elastomer bellows, for external flush with compatible fluid. Rotating head (inboard): Silicon carbide (SiC). Fixed rings: Ceramic (Al<sub>2</sub>O<sub>3</sub>). Manufacturer: HUHNSEAL/DRT (model HNT+AT).

- **M10**

Double external mechanical seal, with O-ring seal, for external flush with compatible fluid. Rotating head (inboard): Silicon carbide (SiC). Fixed rings: Silicon carbide (SiC). Manufacturer: CRANE (model R33/R33).

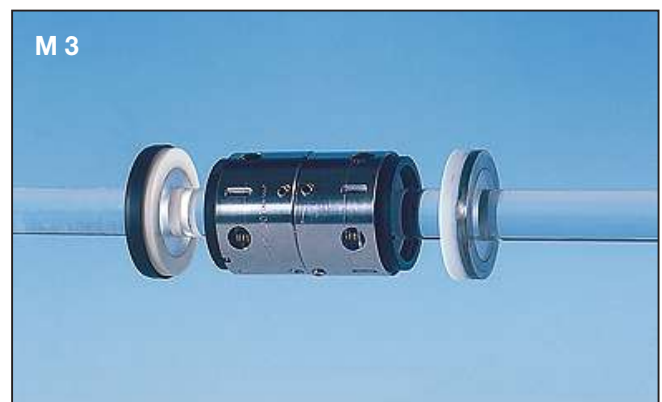



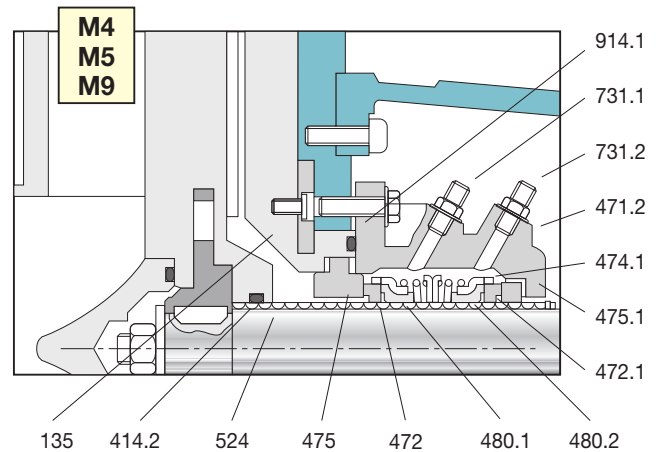
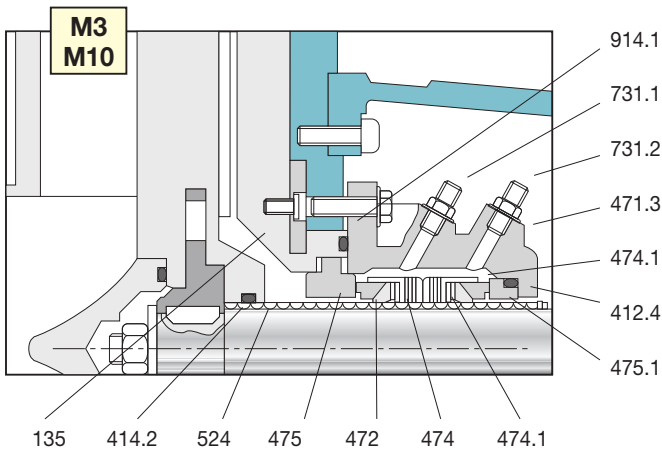
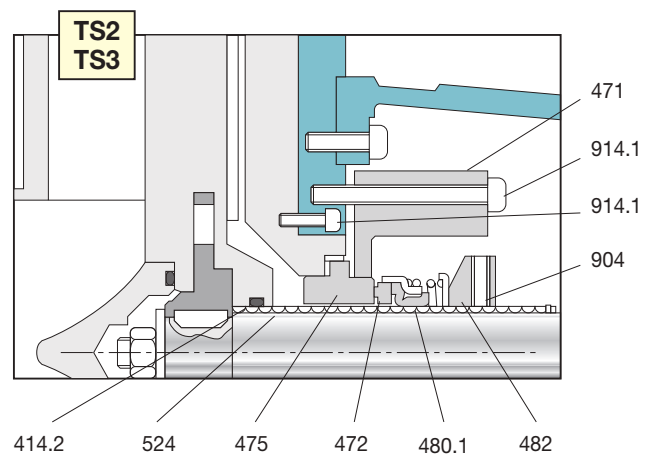
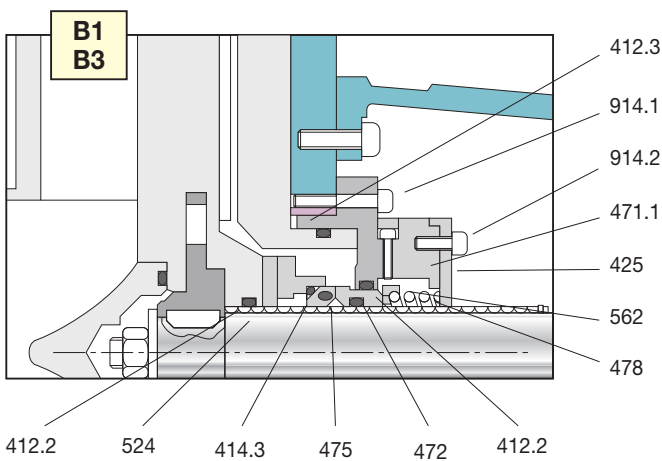
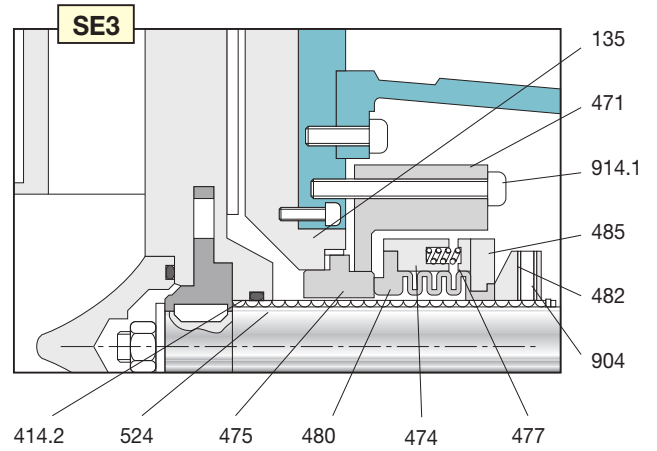
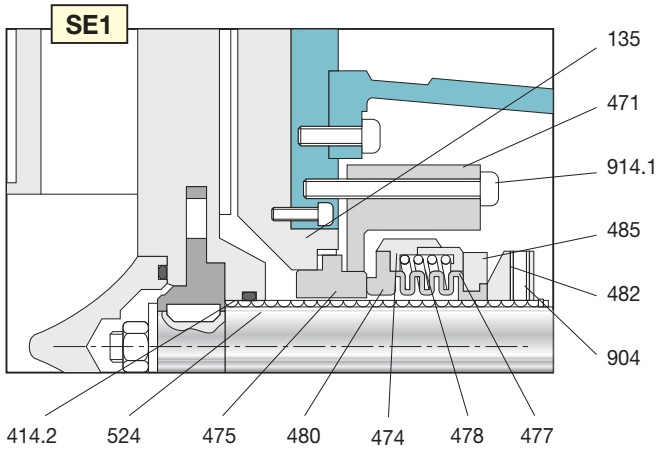

**COMPONENTS OF MECHANICAL SEALS**

table 3

Re.	Components desc.	Re.	Components desc.	Re.	Components desc.
135	Intermediate plate	474	Seal casing	485	Champ
412.2/3	O-ring	474.1	Seal casing	524	Shaft sleeve
412.4	O-ring	475	Fixed seal ring	562	Lock clip
412.2	O-ring	475.1	Fixed seal ring	731.1	Seal washing inlet
412.3	O-ring	477	Thrust spring	731.2	Seal washing outlet
482	Support plate	478	Thrust spring	904	Grub screws
471.1/.2/.3	Seal cover	480	Snap ring with bellows	914.1/.2	Screws
472	Seal ring	480.1	Bellows		
472.1	Seal ring	480.2	Bellows		

## BASE CHOISE - N - (ISO pump / IEC motor)

table 4

MOTOR SIZE	71	80	90 S	90 L	100 L	112 M	132 S	132 M	160 M	160 L	180 M	180 L	200 L	225 S	225 M	250 M	280 S	280 M	315 S	315 M	315 L	355 L	
kW for 2 poles	0,37 0,55	0,75 1,1	1,5	2,2	3	4	5,5 7,5		11 15	18,5	22		30 70		45	55	75	90	110	132	160 200	250	
kW for 4 poles	0,25 0,37	0,55 0,75	1,1	1,5	2,2 3	4	5,5	7,5	11	15	18,5	22	30	37	45	55	75	90		110 132	160 200	250 315	
PUMP MODEL																							
32/125																							
32/160	2	2	2																				
40/125																							
40/160				3	3	3	4	4	5	5													
40/200	2	3	3																				
50/125		2	3																				
50/160		3	3						5	5	5												
50/200																							
50/250		4	4	4	4	4																	
50/315		5	5	5	5	5						6		7	7	8	9						
65/160		3	4	4	4	4																	
65/200		4	4	4			5	5	6	6	6												
65/250		5	5	5	5	5																	
80/200		5																					
80/250		6	6	6	6	6																	
80/315							6	6															
80/400					7	7	7	7	7														
100/250					6	6																	
100/315							6	6	6	7	7												
125/250																							
125/315									8	8	8												
125/400																							
150/250									8	8	8												
150/315																							
150/400																							
200/400																							
250/400																							
300/400																							

## EXAMPLE FOR ORDERING

table 5

RANGE	MODEL	VERSION	IMPELLER	GASKET	SEAL	BASE	POLES	POWER kW
ZGE	40/200	FC	185	V	SE1	N3	4P	1,5
.1	.2	.3	.4	.5	.6	.7	.8	.9
.1: Range name. .2: Pump model. .3: Version (page 5).			.4: Impeller diameter in mm (note page 3) .5: Gasket (page 5). .6: Mecanical seal (page 7).			.7: Base number - ISO 3661; (page 9). .8: Electric motor poles number. .9: Installed power in kW.		

## ISO BASES 3661 (DIN 24 259)

table 6

Base No.	2	3	4	5	6	7	8	9	10	11	12
I1	800	900	100	1120	1250	1400	1600	1800	2300	2500	2900
b1, max	270	300	340	380	430	480	530	600	750	750	750
I2	130	150	170	190	205	230	270	300	250	250	250
I3	540	600	660	740	840	940	1060	1200	1800	2000	2400
I4	35	35	40	40	45	50	55	55			
b2	360	390	450	490	540	610	660	730	950	950	950
b3	320	350	400	440	490	550	600	670	850	850	850
h3, max	125	125	125	140	160	180	200	200	175	240	240
d1	19	19	24	24	24	27	27	27	27	27	27

**DIMENSION TABLE ISO 2858 (DIN 24 256)**

table 7

PUMP MODEL	FLANGED CONNECTION								PUMP DIMENSIONS				PUMP FIXING							SHAFT			a2	
	OUTLET				INLET				a1	f	h1	h2	b	m1	m2	n1	n2	n3	s1	s2	w	x		d
32/125	32	100	4	50	125	4	80	112	140	50	100	70	190	140	110	M12	285	100	24	50	60	75	90	75
32/160																								
40/125	40	110	4	65	145	8	125	112	140	80	160	180	210	160	110	M12	285	100	32	80	90	75	90	75
40/160																								
40/200	40	110	4	65	145	8	125	112	140	80	160	180	210	160	110	M12	285	100	32	80	90	75	90	75
50/125																								
50/160	50	125	4	80	160	8	125	132	160	80	160	180	200	265	212	M12	285	100	32	80	90	75	90	75
50/200																								
50/250	50	125	4	80	160	8	125	132	160	80	160	180	200	265	212	M12	285	100	32	80	90	75	90	75
50/315																								
65/160	65	145	8	100	180	8	125	160	225	65	125	95	320	250	110	M12	285	100	32	80	90	75	90	75
65/200																								
65/250	65	145	8	100	180	8	125	160	225	65	125	95	320	250	110	M12	285	100	32	80	90	75	90	75
80/200																								
80/250	80	160	8	125	210	8	125	180	250	80	160	120	360	280	110	M16	285	100	32	80	90	75	90	75
80/315																								
80/400	80	160	8	125	210	8	125	225	280	80	160	120	400	315	110	M16	285	100	32	80	90	75	90	75
100/250																								
100/315	100	180	8	150	240	8	140	250	315	80	160	120	400	315	110	M16	285	100	32	80	90	75	90	75
125/250																								
125/315	125	210	8	150	240	8	140	280	355	80	160	120	435	355	110	M16	285	100	32	80	90	75	90	75
125/400																								
150/250	150	240	8	200	295	8	160	280	375	100	200	150	500	400	140	M20	285	100	32	80	90	75	90	75
150/315																								
150/400	150	240	8	200	295	8	160	280	375	100	200	150	550	450	140	M20	285	100	32	80	90	75	90	75
200/400																								
250/400	250	350	12	300	400	12	200	700	370	130	250	200	700	575	140	M24	285	100	32	80	90	75	90	75
300/400																								

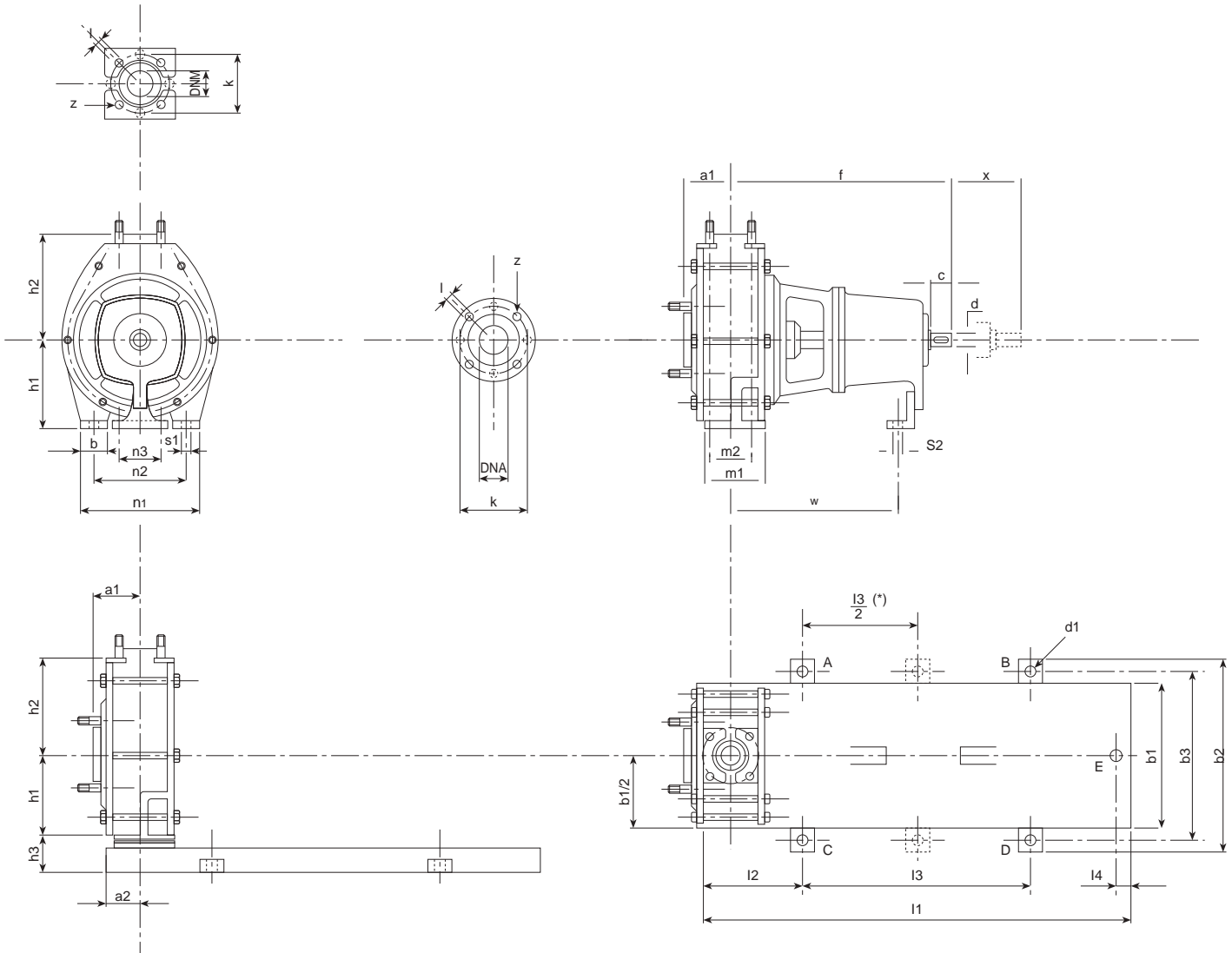

(\*) For base 10-11-12

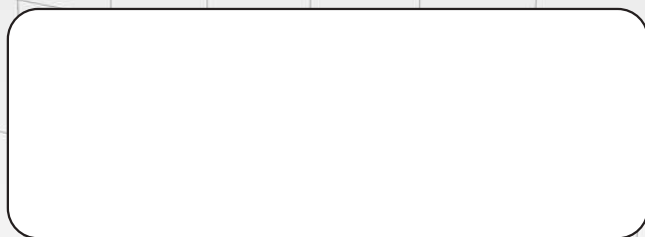

Member of AIB  
associazione  
industriale  
bresciana

IT - 25125 BRESCIA - Via Labirinto, 159  
Tel. +39 030 3507011 - Fax +39 030 3507077  
Export dpt. Tel. +39 030 3507033  
Web: [www.argal.it](http://www.argal.it) - E-mail: [export@argal.it](mailto:export@argal.it)

It is the policy of ARGAL to always improve its products and the right is reserved to alter specifications at any time without prior notice.  
No part of this publication may be reproduced in any form or any means.