

# PRODUCTION PROGRAM

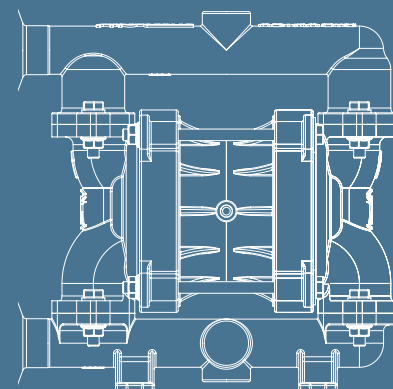

EU product  
Made in Italy

2018

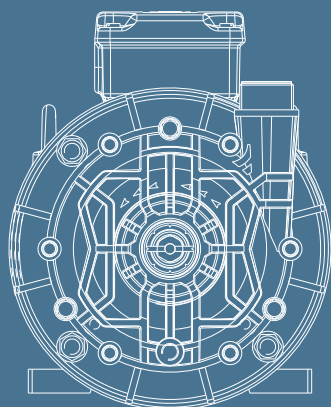
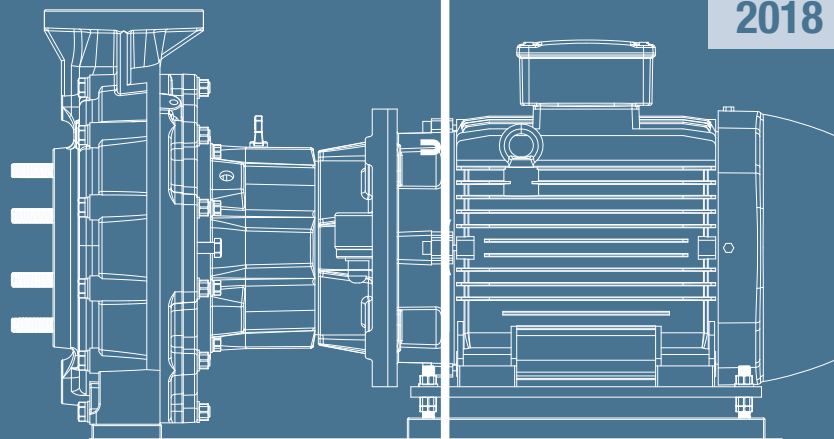

**PUMPS  
FOR SPECIAL  
MEDIA**

**SEALLESS MAG-DRIVE & AODD PUMPS,  
SEALED CENTRIFUGAL  
& VERTICAL SUMP PUMPS**

**SELF-PRIMING PUMPS**



SINCE 1975

EN





AODD  
Pumps  
page 08



Centrifugal  
Pumps  
page 14



Handling Pumps page 16-17  
ISO 2858 Centrifugal Pumps page 18-19  
ANSI B 73.1 Centrifugal Pumps page 20



FRP  
Vertical  
Sump  
Pumps  
page 24



Handling  
Sump  
Pumps  
page 25  
Process  
Sump  
Pumps  
page 26  
FRP  
Sump  
Pumps  
page 21



Self-Priming  
Pumps  
page 22

#INDEX

# QUALITY EXPERIENCE INNOVATION SINCE 1975

**ARGAL**® boasts forty years of activity in the invention and production of pumps made of thermoplastic material, compounds and corrosion-resistant metal alloys. During the past decade, significant efforts were directed to research and development on the entire production and such an effort resulted in pump ranges entirely new or renovated both regarding mechanical and hydraulic systems.

The mission of **ARGAL**® is continuous and constant technological improvement, along the path of innovation instead of emulation. Our aim is to offer the best technical performance and engineering obtaining the leadership in performance while providing appropriate responses to the needs of market dynamics by realizing a “State-of-the-art quality.





Today the company has an extensive range of pumps in various constructions for industrial applications requiring temperatures ranging from  $-40^{\circ}\text{C}$  to  $+120^{\circ}\text{C}$ , with load capacities up to  $1700\text{ m}^3/\text{h}$ -head over the 100 m.

All are **certified ISO 9001:2008 according to Vision ISO 9001:2008 rule**. We strongly want to offer a wide production program with high-quality pumps ranges and competitive prices.



# M

## MATERIALS



Polypropylene



Ethylene-Chloro  
Trifluoro Ethylene



Ultra High Molecular  
Weight Polyethylene



Polyvinyl Chloride



Polyvinylidene  
Fluoride



Poly Tetra Fluoro  
Ethylene



Fiberglass

**+GLASS**

Glass  
reinforced

**+CARBON**

Carbon  
filled



Aluminum



Alloy Duplex



Stainless Steel  
(low Carbon)



Stainless Steel



Bronze

# C

## CERTIFICATIONS/WARRANTY



Atex



Food and Drug Administration



European Conformity



Eurasian Conformity



12 months



24 months



60 months

# #CONTENTS



## TECHNOLOGY



Sealless



Sealed



Self-priming



Submersible



## SERIES

### 1 = TECHNOLOGY

- T** Sealless
- Z** Sealed
- D** Doppia
- K** Vertical

### 2 = CONSTRUCTION

- M** Close-coupled
- G** Long-coupled
- D** a membrana
- M** Close-coupled

### 3 = RANGE NAME

- “P”** rima
- “S”** aturn
- “Q”** uantum
- “E”** quipro

# #AODD PUMPS



AODD (Air-Operated Double Daphragm) pumps made for moving corrosive, abrasive, viscous, neutral liquids or with solids in suspension. They can also operate in dangerous areas (ATEX). Our AODD pumps can vary the flow and are non-stalling, dry-running, self-priming and easy to maintain.





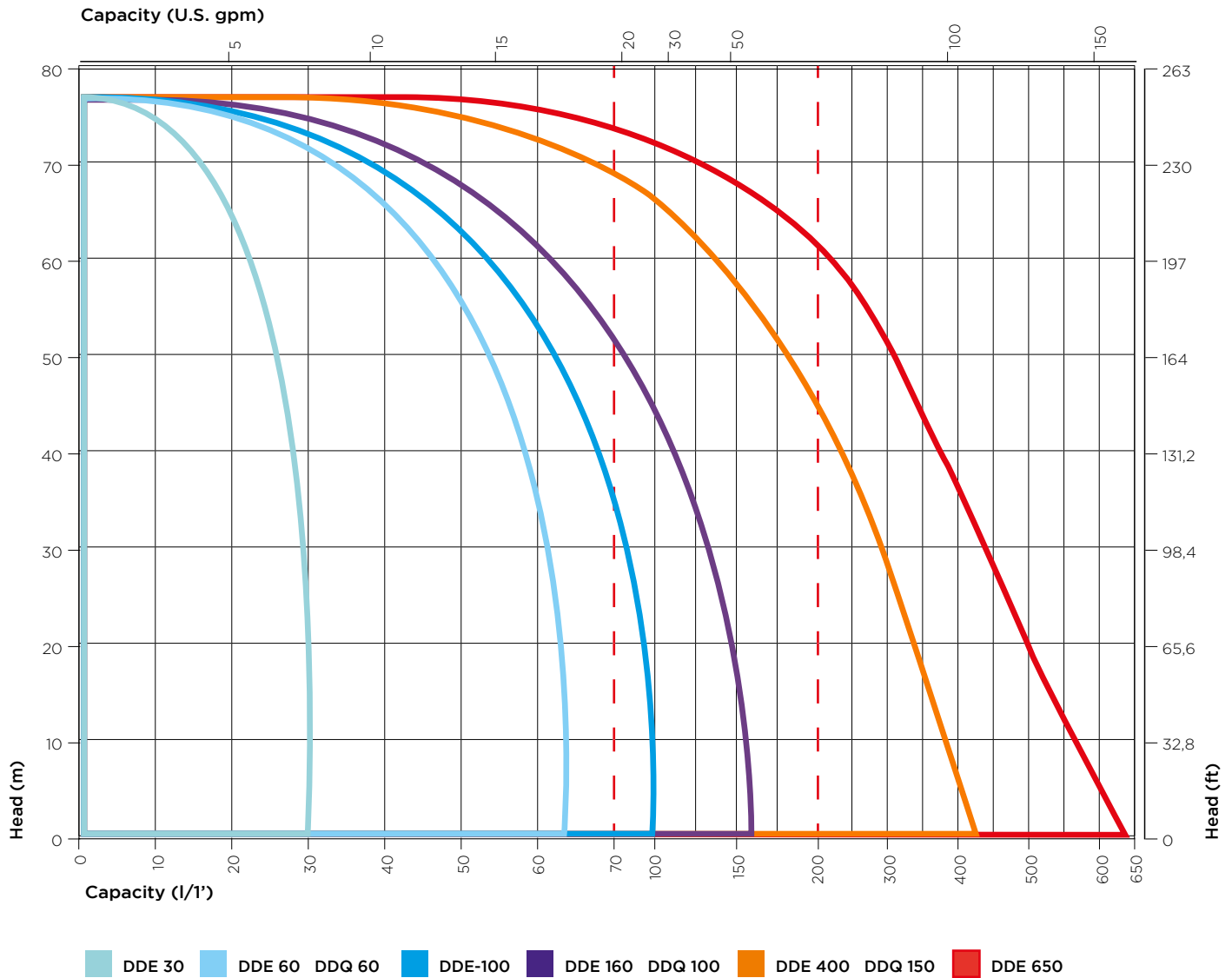



**ATEX:** Ideal for operating in explosive atmospheres according to the ATEX normative **Zone 2** (Serie II 3/3 GD IIB T 135°C) and ATEX **Zone 1** (Serie II 2/2 IIB T 135°C).





## ASTRAEVO (DDE)

- Optimised air consumption;
- Working sensitivity improved (start from 1 bar);
- Ergonomic fixings;
- Bigger inlet pipe for guaranteeing the best performance ever when pumping viscous liquids.
- Advanced caps for a longer lifecycle of the membranes and an easy maintenance;
- Distributor protected from atmospheric agents thanks to a free-acid armour;
- Free ice air-exhaustive system;
- Low noise integrated muffler.

ASTRAEVO (*)	Flow rate (l/min")	Ports (inch)	Materials	Solids (mm)
<b>DDE 30</b> 	30	1/2"	• PP+G • PVDF+C • ALU • AISI 316L	3,5
<b>DDE 60</b> 	65	1/2"	• PP+G • PVDF+C • ALU • AISI 316L	3,5
<b>DDE 100</b> 	100	1"	• PP+G • PVDF+C • ALU • AISI 316L	3,5
<b>DDE 160</b> 	160	1"	• PP+G • PVDF+C • ALU • AISI 316L	7,5
<b>DDE 400</b> 	400	1 1/2"	• PP+G • PVDF+C • ALU • AISI 316L	8,5
<b>DDE 650</b> 	650	2"	• PP+G • PVDF+C • ALU • AISI 316L	8,5

Note: available PP+C for ATEX plastic versions

(\*) Max pressure 8 bar

# MISTRAL (DDM)



## BENEFITS & FUNCTIONALITIES

- Optimised air consumption;
- Designed for continuous applications ;
- Sturdy construction, 5-year guarantee;
- The safest solution in dangerous atmospheres or with risk of explosion (ATEX Zone 1) .
- High capacity with high efficiency.



**Port size:** 2" - 3" - 4"  
**Capacity:** from 70 to 1280 l/m'

**Wetted section** AISI 316 L BR

**Temperatures** +100° -20° (PTFE diaphragms)  
+80° -40° (NBR, EPDM, diaphragms)

**Port size:** 3"

**Wetted section** UPPE

**Temperatures** +95° -20° (PTFE diaphragms)  
+80° -40° (NBR, EPDM, diaphragms)

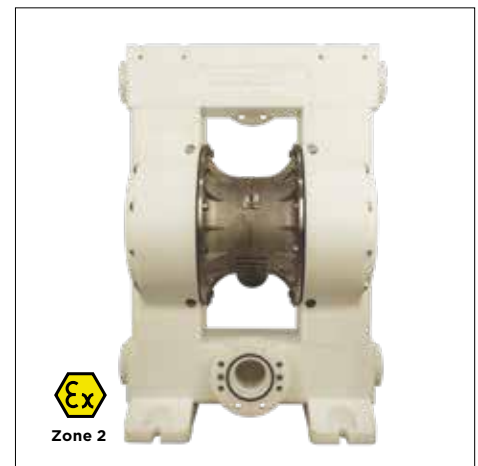

**WORLD FIRST**

**Port size:** 3" - 4"

**Wetted section** FRP

**Temperatures** +100° -20° (PTFE diaphragms)  
+80° -40° (NBR, EPDM, diaphragms)

TECHNICAL DATA	200 (2")	300 (3")	400 (4")
<b>Maximum Capacity Litres/Minute</b>	680	1100	1280
<b>Materials of Pump Housings &amp; Central Block</b>	AISI 316L • BRONZO	AISI 316L • BRONZO • UPPE • FRP	AISI 316L • BRONZO • FRP
<b>Fluid Port (ISO-ANSI Flange) Intake &amp; Discharge Connections</b>	2" BSP	3" DN80	4" DN100
<b>Air Inlet</b>	1/2" F NPT	3/4" F NPT	3/4" F NPT
<b>Air Exhaust (included silencer)</b>	3/4" F NPT	1" F NPT	1" F NPT
<b>Maximum Working Pressure</b>	8 bar	8 bar	8 bar
<b>Maximum Cycles per Minutes</b>	140	96	96
<b>Max. Discharge Volume/Cycles</b>	3,7 litres	8,5 litres	8,5 litres
<b>Maximum Solids Particle Size</b>	9 mm	11 mm	13 mm
<b>Suction Lift (dry)</b>	6 m	6 m	4,5 m

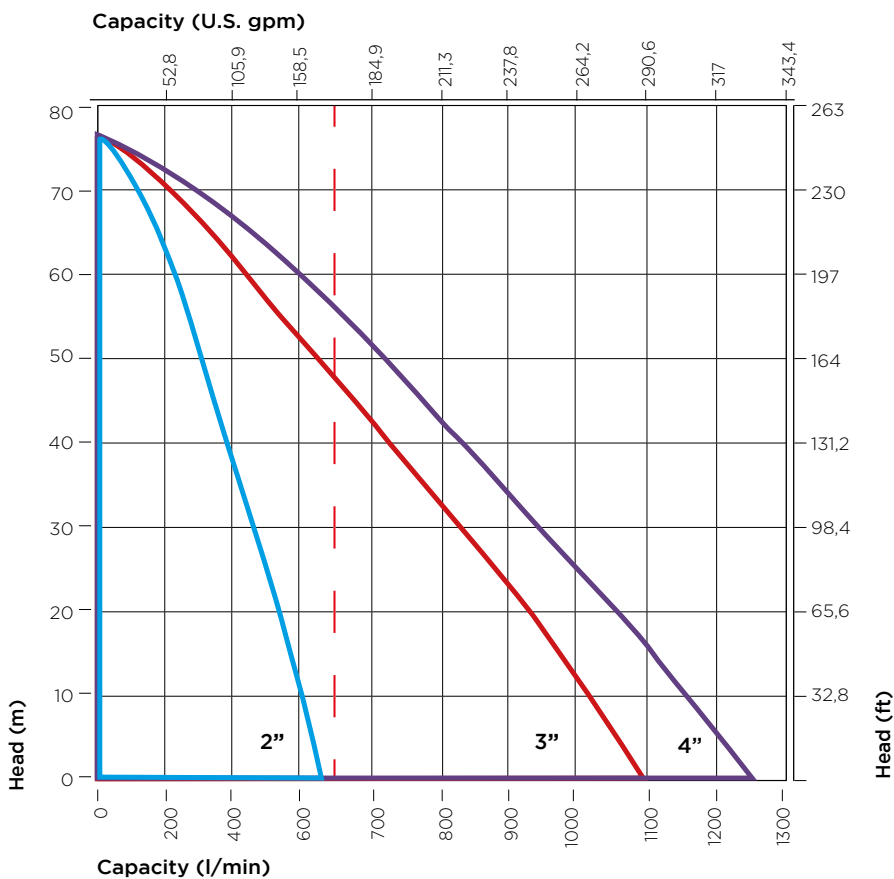

## BENEFITS & FUNCTIONALITIES

- Solid-block construction in pure thermoplastic polymers, high mechanical strength and chemical resistance;
- Any kind of aggressive liquids can be pumped;
- Complete maintenance of the pump on-site (no disassembling needed);
- Optimised air consumption;
- Smart PAD for regulate the flow;
- Pump casing unloading system;
- Non-return valve to protect the distributor from air;
- Double unloading with silencer integrated.



**Port size:** 1/2" - 1" - 1 1/2"

---

**Wetted section**

---

**Temperatures**

UPPE	+70°	-40°
PTFE	+120°	-20°

## QUANTUM'S PLUS

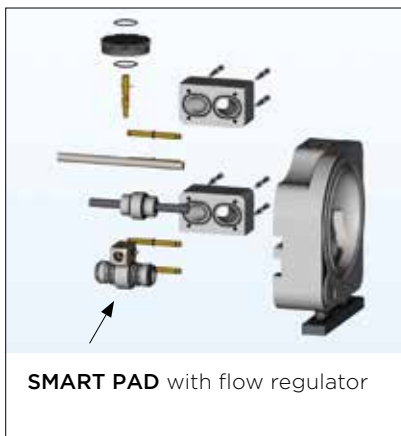

## INNOVATIVE COMPONENTS

TECHNICAL DATA	DDQ60 (1/2")	DDQ160 (1")	DDQ400 (1" 1/2)
<b>Maximum Capacity Litres/Minute</b>	60	160	400
<b>Materials of Pump Housings &amp; Central Block</b>	UPPE • PTFE	UPPE • PTFE	UPPE • PTFE
<b>Fluid connection</b>	G 1/2" BSP	G 1" BSP	G 1 1/2" BSP
<b>Air connection</b>	G 1/4" BSP	G 3/8" BSP	G 1/2" BSP
<b>Max delivery head</b>	80 mca	80 mca	80 mca
<b>Max air pressure</b>	8 bar	8 bar	8 bar
<b>Max suction lift dry</b>	4 mca	4 mca	4 mca
<b>Max suction lift wet</b>	9 mca	9 mca	9 mca
<b>Max size solids</b>	7,5 mm	11 mm	19 mm
<b>Noise level</b>	72 dB(A)	78 dB(A)	83 dB(A)

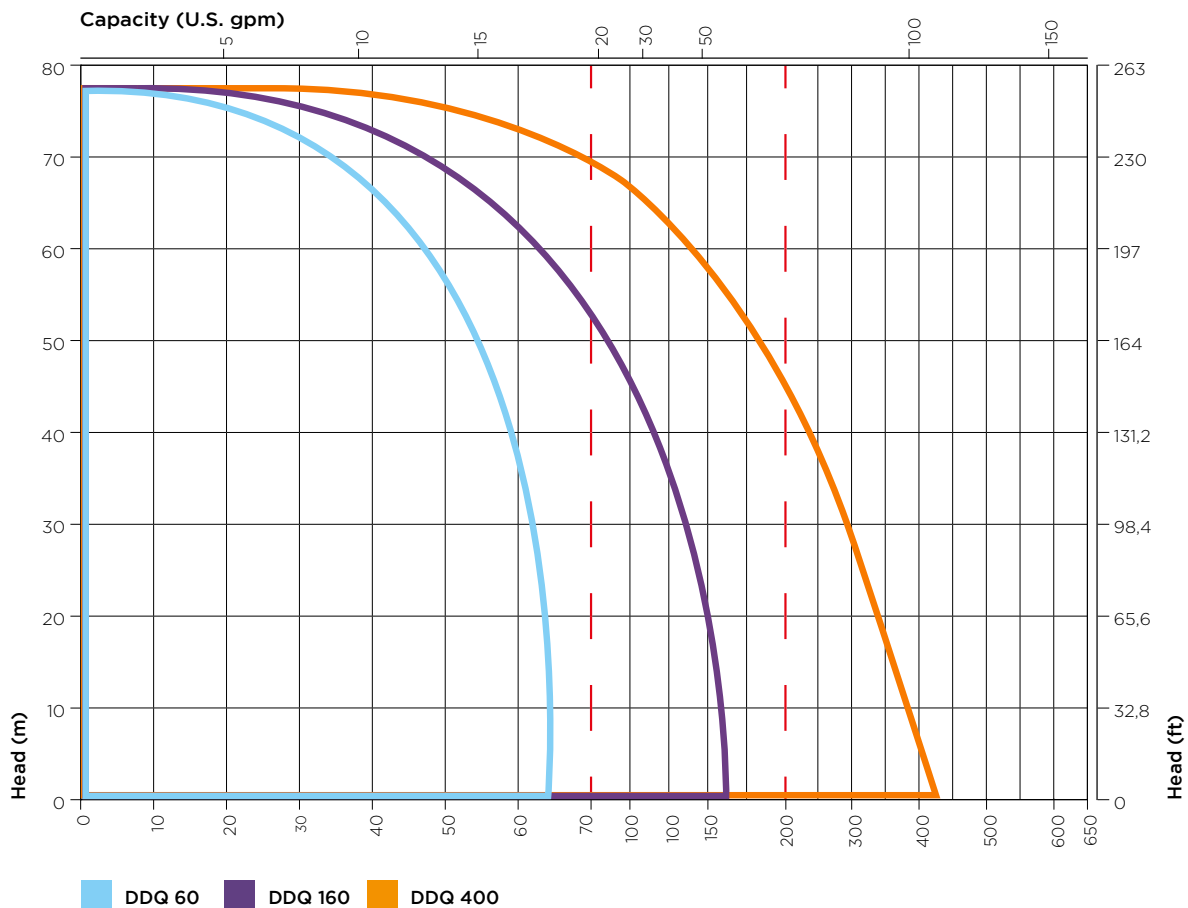

# #HORIZONTAL CENTRIFUGAL PUMPS

50HZ

The “chemical pumps” with horizontal axis by ARGAL® boast the following important features:

**1** • Pump liquids with a specific gravity ranging between 1 and 2 kg/cm<sup>3</sup> without having to reduce performance but by installing adequate horsepower engines;

**2** • the use of E-CTFE such as fluoropolymer that offers a chemical resistance unparalleled when compared to any injection moulded polymer;

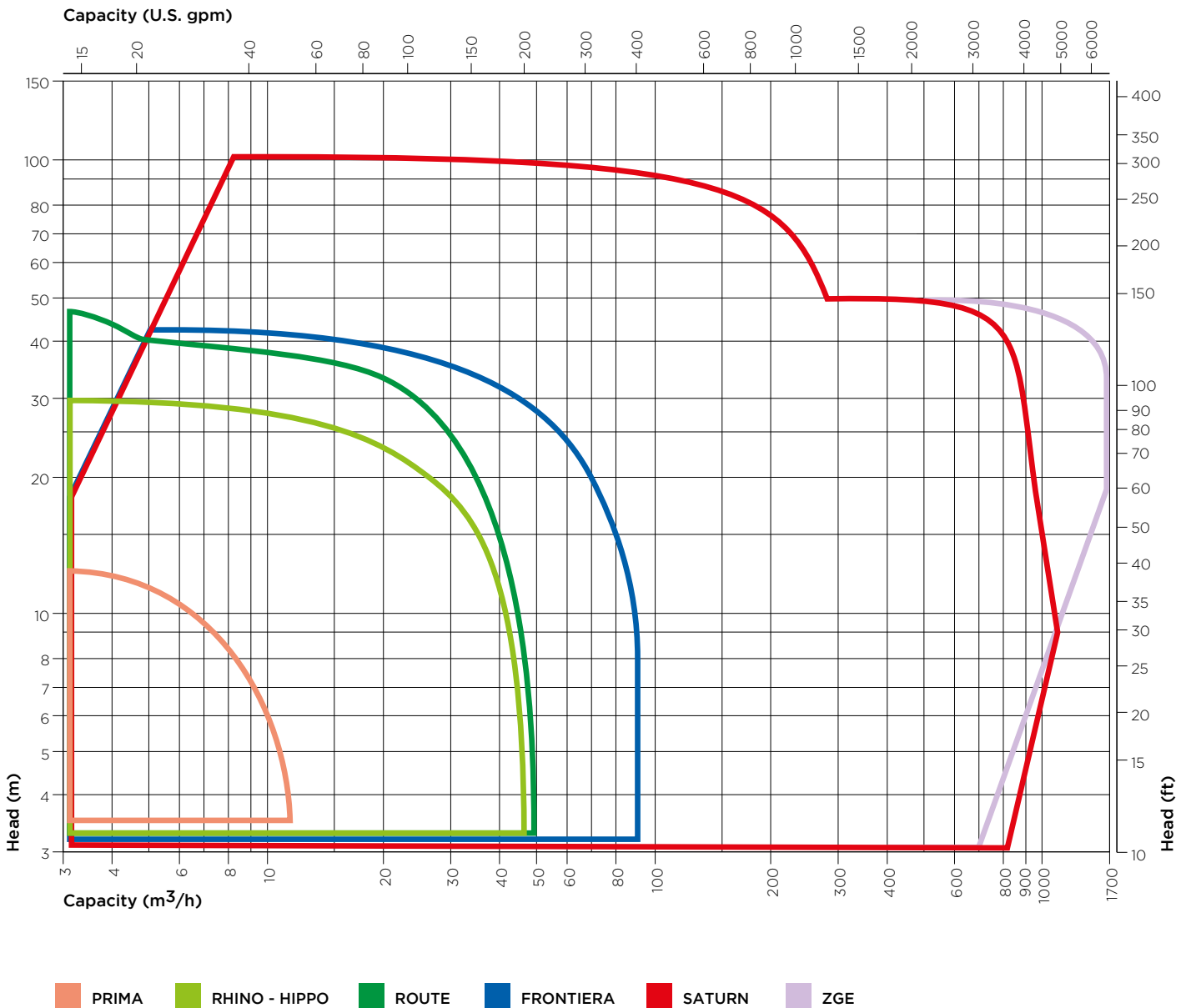

# 60HZ

# #HORIZONTAL CENTRIFUGAL PUMPS

- 3 • up to 90 mc/h flow rate delivered by either magnetic drive pumps or mechanical sealed pumps;
- 4 • The close coupled pumps process executions have stayed an additional bearing to support

those of the electric motor;

- 5 • All equipment, including monobloc ones, involves the use of standardized electric motors.

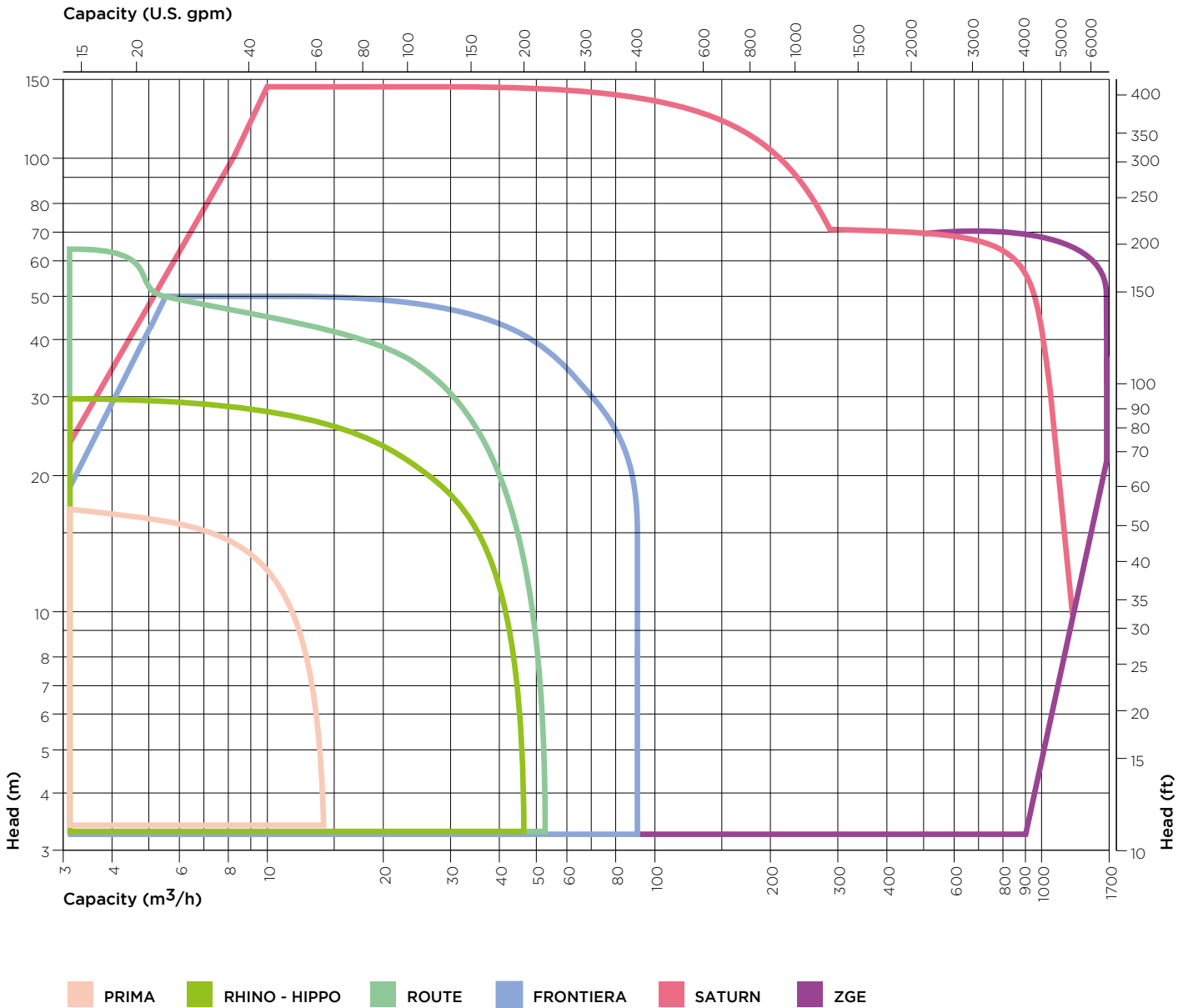

# #HANDLING PUMPS

## BASIS TMB



### BENEFITS & FUNCTIONALITIES

- Compact design;
- Low noise;
- No sealing components ;
- Threaded and hose connections.



<b>Capacity:</b>	up to 70l/min.		
<b>Construction:</b>	Close-coupled		
<b>Motor powers:</b>	W 15 ÷ 100		
<b>Wetted section</b>	<b>PP</b>	<b>E-CTFE</b>	(mod. TMB35)
	+ Glass	+ Carbon	
<b>Temperatures</b>	<b>PP+G</b>	+60°	-5°
	<b>E-CTFE+C</b>	+90°	-20°

## PRIMA TMP



### BENEFITS & FUNCTIONALITIES

- No sealing components;
- No metallic part in contact with the liquid
- Threaded or flanged connections.

<b>Capacity:</b>	up to 12 m <sup>3</sup> /h		
<b>Construction:</b>	Close-coupled		
<b>Motor powers:</b>	kW 0,18 ÷ 1,1		
<b>Wetted section</b>	<b>PP</b>	<b>E-CTFE</b>	
	+ Glass	+ Carbon	
<b>Temperatures</b>	<b>PP+G</b>	+60°	-5°
	<b>E-CTFE+C</b>	+90°	-20°





## ROUTE



### BENEFITS & FUNCTIONALITIES

- Mag-driven for clean liquids
- Mech-sealed for dirty or abrasive liquids ;
- Threaded or flanged connections .

<b>Capacity:</b>	up to 50 m <sup>3</sup> /h	
<b>Construction:</b>	Close-coupled	
<b>Motor powers:</b>	kW 0,55 ÷ 11	
<b>Wetted section</b>	<b>PP</b> + Glass	<b>E-CTFE</b> + Carbon
<b>Temperatures</b>	<b>PP+G</b> +60°   -5° <b>E-CTFE+C</b> +100° -20°	



<b>Capacity:</b>	up to 50 m <sup>3</sup> /h	
<b>Construction:</b>	Close-coupled	
<b>Motor powers:</b>	kW 0,55 ÷ 11	
<b>Wetted section</b>	<b>PP</b> + Glass	<b>E-CTFE</b> + Carbon
<b>Temperatures</b>	<b>PP+G</b> +60°   -5° <b>E-CTFE+C</b> +100° -20°	



Patent video

The magnetic drive pump features the patented “bi-directional axial self-alignment system” which allows, for the “R” configuration, the dry running.

The combination of adequate materials of the driving system of the impeller with a specific magnetic field wholly eliminates all frontal frictions that are the cause of breakage when dry running. It is possible to couple standard motors without disassembling the pump.

# #ISO 2858 STANDARD CENTRIFUGAL PUMPS

## FRONTIERA



### BENEFITS & FUNCTIONALITIES

- ISO 2858 standard;
- Mech-sealed or mag-driven;
- Close or long coupled;
- External armour made of AISI 316 (optional);
- Backpull-Out (long-coupled version)
- Wet-end (mag-driven versions)
- Further bearing on motor side (close-coupled version only).

4 versions are available: 2 magnetic driven (TGF - ZGF) and 2 mechanical sealed (TMF - ZMF)

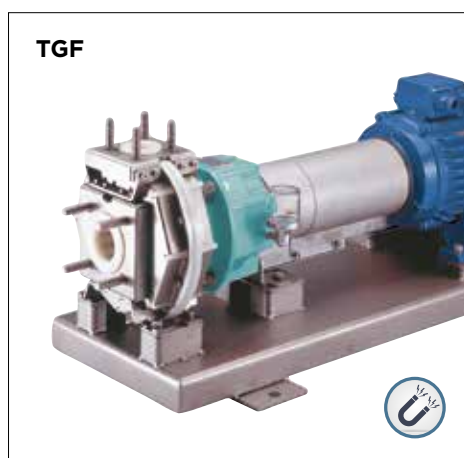

<b>Capacity:</b>	up to 90 m <sup>3</sup> /h		
<b>Construction:</b>	Close-coupled or Long-coupled		
<b>Motor powers:</b>	kW 0,55 ÷ 15		
<b>Wetted section</b>	PP	E-CTFE	
<b>Temperatures</b>	PP	+80°	-5°
	E-CTFE	+100°	-20°

<b>Capacity:</b>	up to 90 m <sup>3</sup> /h		
<b>Construction:</b>	Close-coupled or Long-coupled		
<b>Motor powers:</b>	kW 0,55 ÷ 15		
<b>Wetted section</b>	PP	E-CTFE	
<b>Temperatures</b>	PP	+80°	-5°
	E-CTFE	+100°	-20°



The pump casing is made of fluoropolymer with a nerve shape of 8-10mm thickness should be covered with an AISI 316 armour. These materials ensure the maximum protection level and chemical resistance.

# #ISO 2858 STANDARD CENTRIFUGAL PUMPS

**EUROPA (ZGE)**



**PLUS**

- ISO 2858 standard;
- Solid-block construction in pure thermoplastic polymers, outside armour in cast iron;
- Backpull-Out
- High capacity.

<b>Capacity:</b>	up to 1.700 m <sup>3</sup> /h		
<b>Construction:</b>	Long-coupled		
<b>Motor powers:</b>	kW 0,5 ÷ 200		
<b>Wetted section</b>			
<b>Temperatures</b>	<b>U-PVC</b>	<b>+40°</b>	<b>0°</b>
	<b>PP</b>	<b>+80°</b>	<b>-5°</b>
	<b>PVDF</b>	<b>+100°</b>	<b>-20°</b>
	<b>UPPE</b>	<b>+70°</b>	<b>-40°</b>

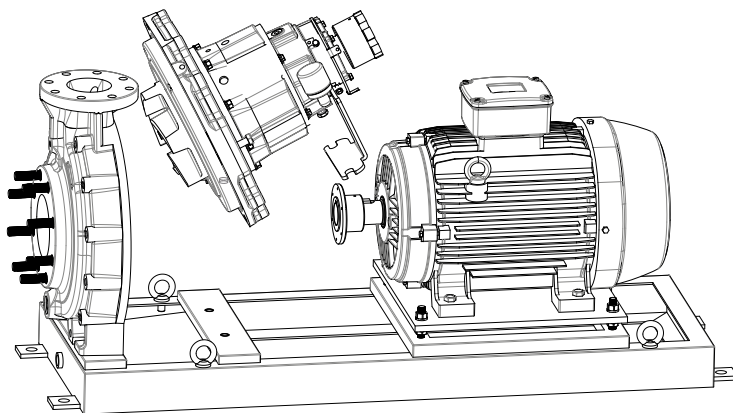

**Back pull-out execution**

All the pumps with elastic coupling are equipped with the back pull-out system that allows the dismantling of the internal and mechanic parts of the pump without disconnecting the casing from the fittings and without moving the motor.

# #ANSI/ASME B 73.1 CENTRIFUGAL PUMPS

## SATURN evo



### A EUROPEAN FIRST

- Entirely realised in vynilester resin (FRP);
- Abrasion and corrosion resistance ;
- Sturdy construction;
- Close or long-coupled;
- FRP Impeller carbon filled;
- Feet and flanges reinforced in Kevlar;
- High efficiency and performance;
- ATEX version available (VIX).

Saturn pumps are available in two versions: **ZGS (long-coupled)** and **ZMS (close-coupled)**.

<b>Capacity:</b>	up to 1.350 m <sup>3</sup> /h
<b>Construction:</b>	Long-coupled
<b>Motor powers:</b>	kW 1,5 ÷ 200
<b>Wetted section</b>	FRP
<b>Temperatures</b>	+115° -35°

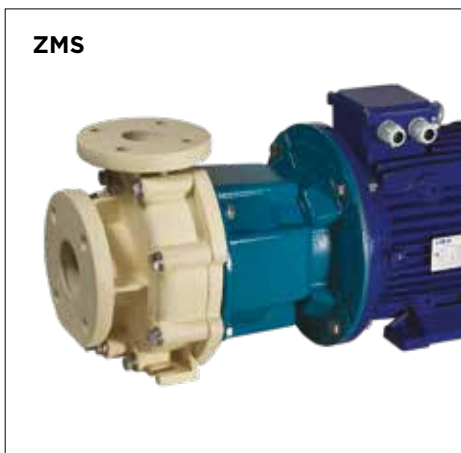

<b>Capacity:</b>	up to 300 m <sup>3</sup> /h
<b>Construction:</b>	Close-coupled
<b>Motor powers:</b>	kW 1,5 ÷ 37
<b>Wetted section</b>	FRP
<b>Temperatures</b>	+115° -35°

**VIG:** the ideal solution for the major part of corrosive agents containing acids, alkalies, detergents, sea water, brine, etc.

**VIA:** for liquids with a low concentration of abrasion: fossil shell flour, ashes, titanium dioxide.

**VIC:** Perfect for resisting to bleach corrosive liquids such as sodium hypochlorite (NaOCl) or hydroxide peroxide (H<sub>2</sub>O<sub>2</sub>);

**VIF:** a specific solution made up with a synthetic veil to ensure resistance to fluoride acid (HF) and other liquids with fluorine.

**VIX:** a specific solution to operate into ATEX areas with conductive resin liner.

# #SUMP PUMPS CENTRIFUGAL PUMPS

## SATURN<sub>sump</sub> (KGS)

### A EUROPEAN FIRST

- Entirely realised in vynilester resin (FRP);
- High efficiency and performance;
- FRP Impeller carbon filled;
- Screws made of FRP, AISI 316L or titanium
- External flushing;
- Shaft made of AISI 316 or Duplex;
- ATEX version available.

Column length under plate up to 5 meters.



**Capacity:** up to 1350 m<sup>3</sup>/h  
**Motor powers:** kW 1,5 ÷ 55

**Material of submerged parts**

FRP

**Temperatures** FRP +100° -10°



**FIBERGLASS IMPELLER  
WITH CARBON FIBER  
BLADES CORE**

**STRAINER**



# #SELF-PRIMING PUMPS

The “vertical pumps” by **ARGAL®** boast the following important features:

- pumping liquids with a specific gravity ranging between 1 and 2 Kg/cm<sup>3</sup> without reducing performance by installing electric motors of increased power;

- in magnetic versions, the use of E-CTFE such as fluoropolymer that offers an unparalleled chemical resistance when compared to other injection moulded polymers;
- Close-coupled pumps with standardized electric motors.

## RHINO TMA



### PLUS

- Reduced self-priming times;
- Biphasic impeller: for liquids with high density

- or high vapour pressure ;
- Up to 6m of self-prime.



**Capacity:** up to 17 m<sup>3</sup>/h  
**Construction:** Close-coupled  
**Motor powers:** kW 2,2 ÷ 4

**Wetted section**

 <b>PP</b> + Glass	 <b>E-CTFE</b> + Carbon
---	---

**Temperatures**

<b>PP+G</b>	<b>+60°</b>	<b>-5°</b>
<b>E-CTFE+C</b>	<b>+100°</b>	<b>-20°</b>

### BIPHASIC IMPELLER

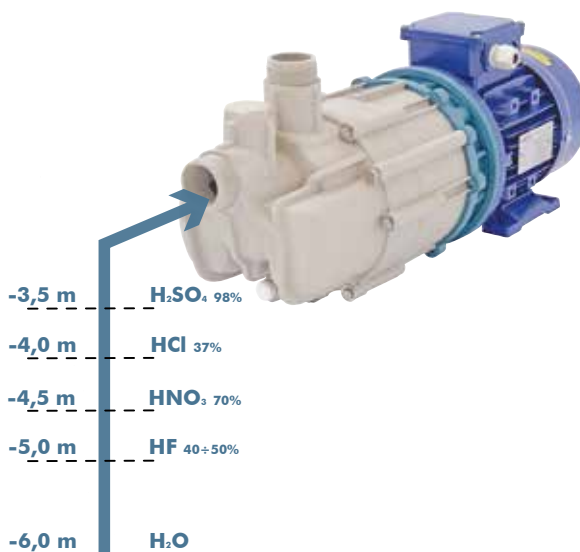

# #SELF-PRIMING PUMPS

## ELK TMA



### PLUS

- Super reduced self-priming times;
- Reversible flow direction.
- Up to 6m of self-prime.

**Capacity:** up to 40 l/1'  
**Construction:** Close-coupled  
**Motor powers:** kW 0,55 ÷ 1,1

**Wetted section**

<b>PP</b>	<b>E-CTFE</b>
+ Glass	+ Carbon

<b>Temperatures</b>	<b>PP+G</b>	<b>+60°</b>	<b>-5°</b>
	<b>E-CTFE+C</b>	<b>+100°</b>	<b>-20°</b>



## HIPPO ZMA



### PLUS

- Solid-block construction in pure thermoplastic polymers;
- Suitable for laden liquids with solids;
- Up to 4,5m of self-prime.



**Capacity:** up to 50 m<sup>3</sup>/h  
**Construction:** Close-coupled  
**Motor powers:** kW 0,55 ÷ 7,5

**Wetted section**

<b>U-PVC</b>	<b>PP</b>	<b>PVDF</b>
--------------	-----------	-------------

<b>Temperatures</b>	<b>U-PVC</b>	<b>+40°</b>	<b>0°</b>
	<b>PP</b>	<b>+70°</b>	<b>-10°</b>
	<b>PVDF</b>	<b>+100°</b>	<b>-30°</b>

### MECHANICAL SEALS



# #HANDLING SUMP PUMPS

The “vertical pumps” by **ARGAL®** boast the following important features:

- Pump liquids with a specific gravity ranging between 1 and 2 kg/cm<sup>3</sup> reducing performance by installing electric motor of adequate power rating;
- combinations of immersed bushing to guide the shaft in anti-abrasion materials;
- effective vapour sealing systems to protect mechanical parts;
- pump column reinforced with FRP (for strength and elongation containment);
- exclusive use of standardized electric motors also for monobloc constructions.
- ATEX version available.

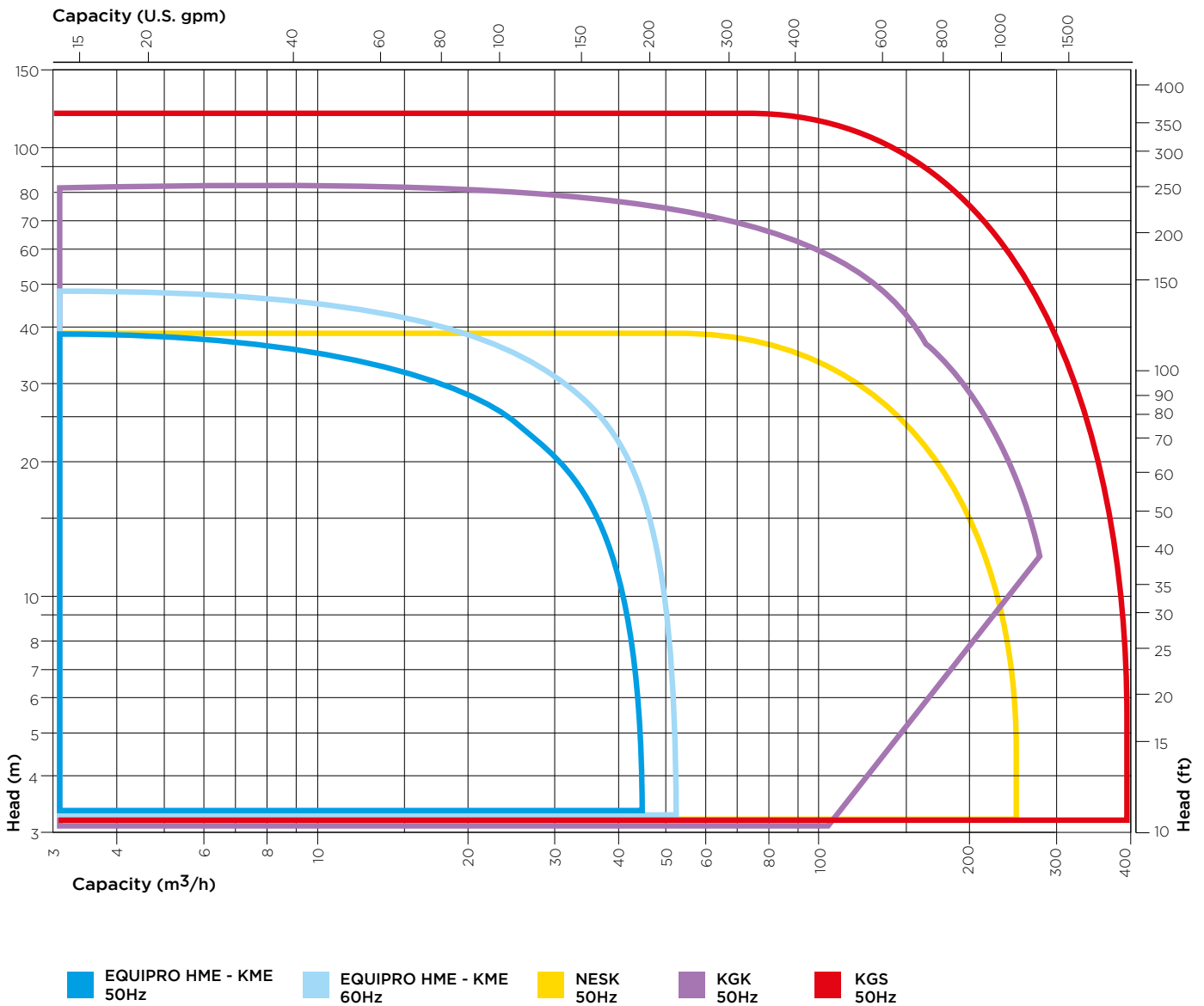



# #HANDLING SUMP PUMPS



## RANGE EQUIPRO HME

- Cantilever pump ideal for laden liquids with solids;
- Column length under plate mm 275 or 450;
- Dry vapour steam seal;
- Inside or outside installation.

**Capacity:** up to 50 m<sup>3</sup>/h  
**Motor powers:** kW 0,25 ÷ 7,5

**Wetted section**

<b>PP</b>	<b>PVDF</b>
+ Glass	+ Carbon

**Temperatures**

<b>PP+G*</b>	<b>+60°</b>	<b>0°</b>
<b>PVDF+C*</b>	<b>+90°</b>	<b>-10°</b>

\* (to be reduced as function of column length)



## RANGE EQUIPRO KME



- Guide system with SIC and CER bushing;
- The under plate column length up to 1,5 meters;
- Dry vapour steam seal;
- Easy assembling and IEC motor alligment.



**Capacity:** up to 50 m<sup>3</sup>/h  
**Motor powers:** kW 0,55 ÷ 11

**Wetted section**

<b>PP</b>	<b>PVDF</b>
+ Glass	+ Carbon

**Temperatures**

<b>PP+G*</b>	<b>+60°</b>	<b>0°</b>
<b>PVDF+C*</b>	<b>+90°</b>	<b>-10°</b>

\* (to be reduced as function of column length)

# #SUMP PUMPS CENTRIFUGAL

## K2 RANGE KGK



- No metal parts in contact with the fluid (screw included);
- CER and SIC guide system with external flushing;
- Pumping laden media with solids;
- The under plate column length up to 4 meters.
- FRP column to handling thermal dilatation;
- Sump column up to 4m;
- Semi-axial impeller (G3 size);
- Single or double stage.

**ATEX VERSION AVAILABLE.**



**Capacity:** up to 275 m<sup>3</sup>/h  
**Motor powers:** kW 0,55 ÷ 45

**Wetted section**

PP  
+ Glass

PVDF  
+ Carbon

**Material of submerged parts**

PP

PP + FRP

PVDF

PVDF + FRP

**Temperatures**

PP+G +60° 0°  
(to be reduced as function of column length)

PP+FRP +70° 0°

PVDF+C +90° -10°  
(to be reduced as function of column length)

PVDF+FRP +90° -10°

# #SATURN INSTALLATIONS



**CHINA, Aquatic Park** - Supplying tank with sea water



**USA, Chemical plant** -  
Caustic soda transfer



**KUWAIT, Desalination plant**  
Intake Pump. The very first Saturn



**CHINA, Aquatic Park** - Supplying tank with sea water



**ITALY, Desalination plant**



**THAILAND, Electrochlorination plant**  
Hypochlorite and seawater dosing pumps

**ARGAL AIR**

**AIR-METERING &  
AODD PUMPS  
PULSATION  
DAMPENERS**

**VERTICAL SUMP  
PUMPS**

**MAG-DRIVE &  
MECH-SEALED  
CENTRIFUGAL  
PUMPS**



**SUBMERSIBLE  
PUMPS**

**SELF-PRIMING  
PUMPS**

**ARGAL srl**

Via Labirinto, 159 - 25125 BRESCIA - (Italy)  
Phone +39 030 3507011 - fax +39 030 3507077  
info@argal.it - [www.argalpumps.com](http://www.argalpumps.com)



cod. 01-18 • EN