

EASTERN[®] Centrichem[™]

**Centrifugal pumps for dependable
service in the process industries.**

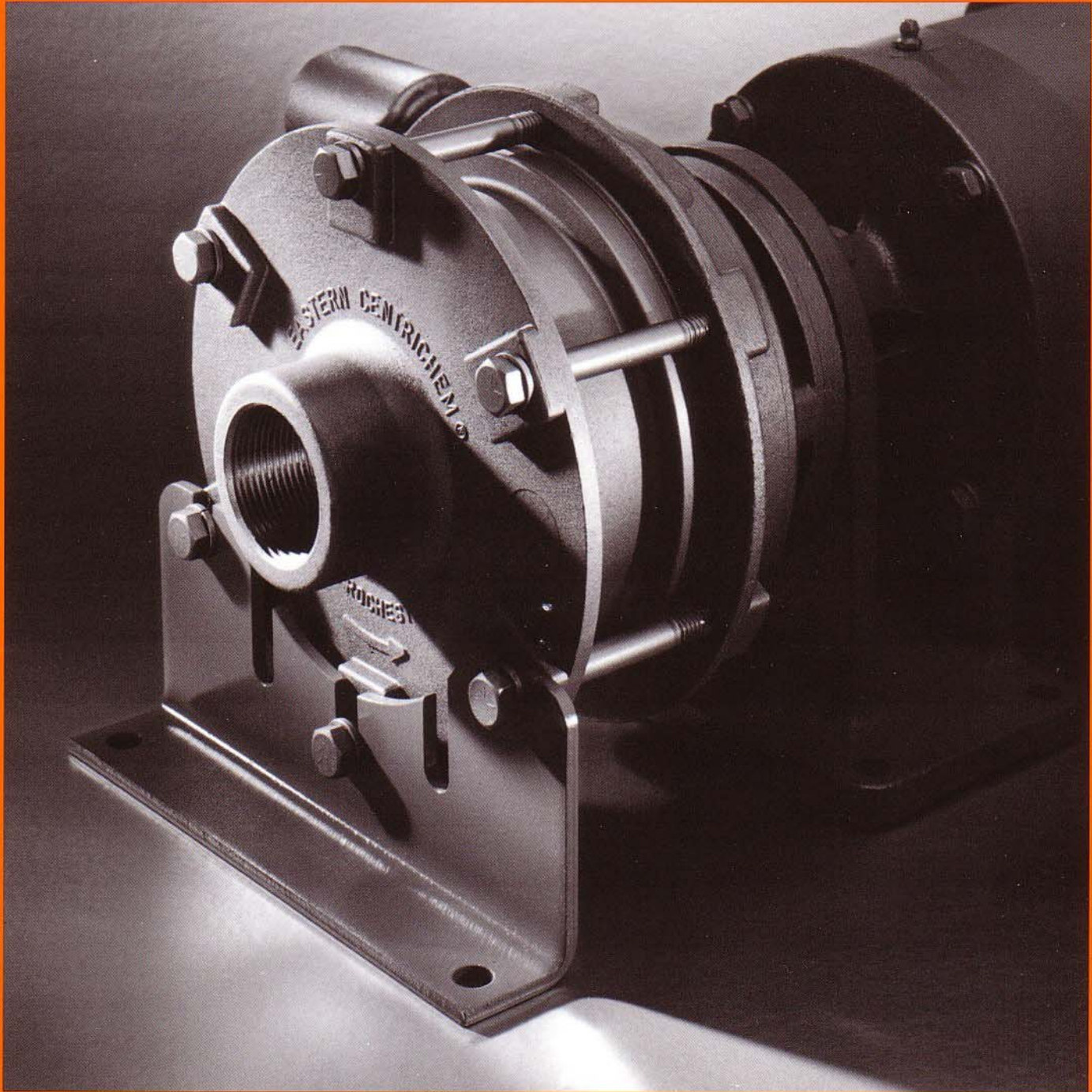

 PULSAFEEDER[®]

Eastern® Centrichem™ pumps are built to last.

Eastern® Centrichem single-stage and multi-stage centrifugal pumps are designed for a wide variety of process industry applications, pilot plant operations, and laboratory uses.

And, just as important, they are designed for long, dependable service.

Construction: Each Centrichem pump is close coupled for greater strength, and comes ready to mount directly to NEMA 56C or 143/5TC or 182/4C motors. This design eliminates the need for special base-plate mountings, couplings, or complicated drives.

Pump chambers, rear housings, covers and impellers are all precision castings to ensure that pump walls are smooth. This avoids crevices which can lead to product contamination.

Precision castings also reduce flow resistance to a minimum. This improves their hydraulic efficiencies to a level unmatched in pumps of this size.

Generous clearance and the overhung shaft design of the single-stage pumps enable them to handle corrosive

liquids that contain low percentages of solids.

And their mechanical rotary seals make these pumps suitable for extensive applications with acids, alkalis, and solvents.

Motors: The standard motors for Eastern Centrichem pumps can be either single or three phase, 115/230 or 230/460 volt, 60 Hertz, TEFC motors. But we can furnish motors with other electrical characteristics, or enclosures, as needed.

For general purpose applications or with excessive amounts of dust, dirt, or similar foreign materials that might harm the motor, we'll provide totally enclosed motors.

For hazardous applications involving flammable liquids or vapors we recommend explosion proof motors (approved by Underwriters Laboratories for Class 1 or 2 hazardous locations) equipped with explosion proof junction boxes. Continuous duty motors come standard on our industrial model pumps.

Air motors are also available.

Materials: Eastern Centrichem™ pumps are available in 316 stainless steel and Alloy C. These materials are suitable for a wide variety of acid and alkali solutions. Please consult our Chemical Resistance Chart for proper selection of metallurgy and shaft seal combinations.

Operating limits: Eastern's model D&J pumps are rated at temperatures up to 250°F, models C&H can go to 450°F, and viscosities up to 100 centipoises.

Dimensions: This brochure provides dimensional data for pumps with adaptors only. Certified dimension prints for specific pump and motor combinations will be furnished upon request, as motor dimensions vary by manufacturer.

Engineering: Eastern will modify or adapt our pumps to meet severe or unusual service conditions. Also, we can manufacture specialized pumps to meet specific application requirements. Contact your local Eastern distributor for assistance in determining what, if any—modifications you need.

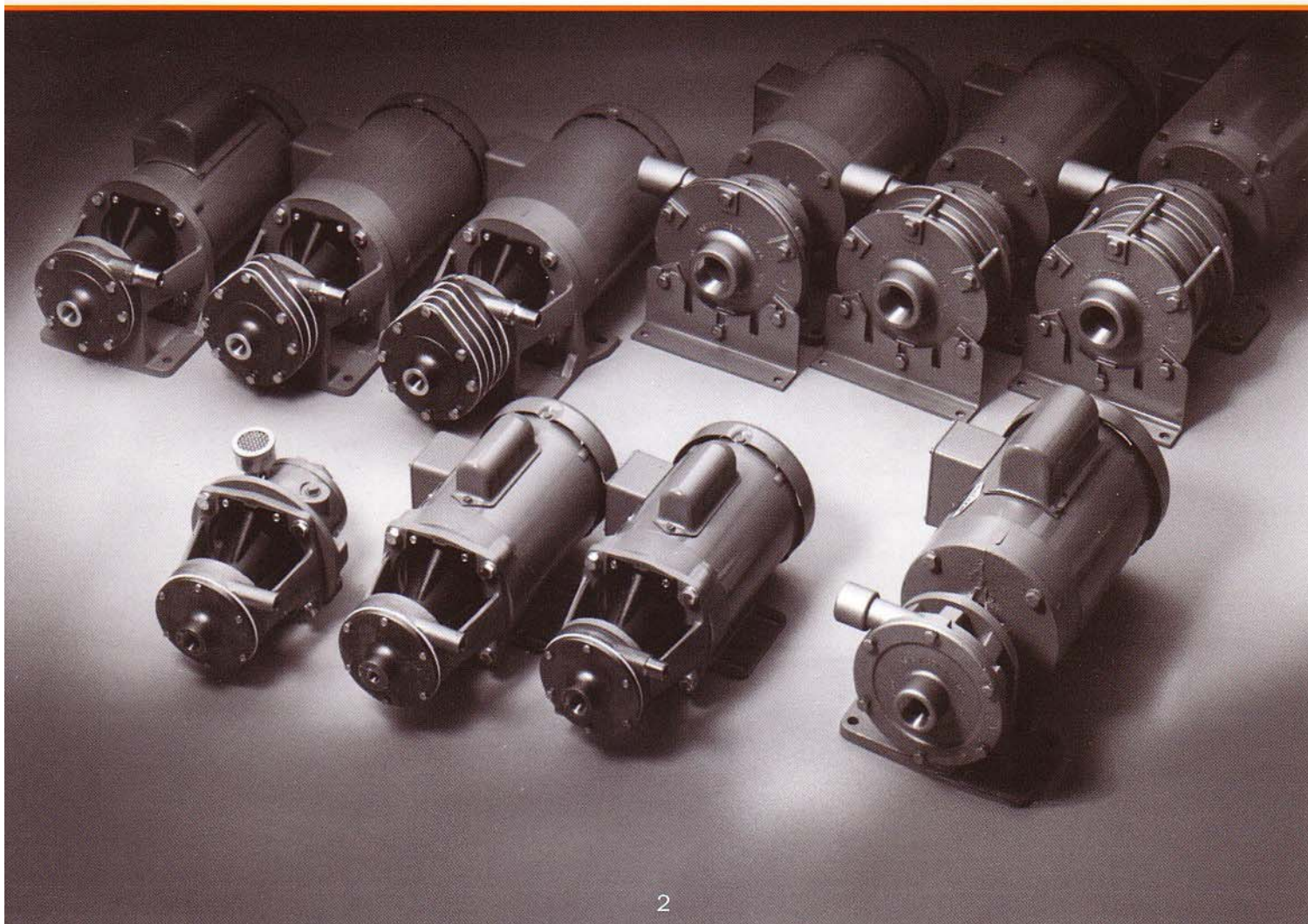

Eastern Centrichem™ pumps offer the features you need.

Eastern Centrichem pumps are available in twelve models. Each model is specifically designed for continuous duty transfer or circulating operation service within the process industries.

Eastern Centrichem pumps use state-of-the-art seals

Eastern Centrichem pumps utilize mechanical seals exclusively on all models. Mechanical seals are the preferred sealing method in most applications, and offer many advantages over conventional packed stuffing boxes.

- reduced friction and power loss
- zero leakage of product
- elimination of shaft wear

A wide variety of seal configurations provide the best selection of elastomers and mating faces in order to handle a

wide range of corrosive liquids. To make sure you select the right seal, careful consideration must be given to the service and operating conditions of each specific application.

Type 21® and Type 9® seals cover the widest range of services. These seals are dimensionally interchangeable. They operate in the same manner, using spring tension to keep their stationary and rotating faces in contact.

Primary sealing is accomplished by interaction of the lapped stationary and rotating faces. Secondary sealing occurs at the shaft by means of a tight fitting bellows in the Type 21 design, or a Teflon® wedge in the Type 9 arrangement. The final sealing point occurs at the static seat by means of either an elas-

tomeric O-ring, or a Teflon® seat ring.

The Type 9 seal is designed for demanding applications. Its head is fixed to the shaft by anti-rotation pins or set screws, and utilizes a TFE wedge between the seal ring and shaft. This wedge improves sealing and extends compatibility with most chemicals. All metal components of the seal are either 316 ss or Alloy C. The rotary face is chemical grade carbon or Teflon and the seat is silicon carbide. The Type 9 seal is available in double configuration for more demanding or hazardous applications.

The Type 21 seal is the more economical of the two. It uses an elastomeric bellows to hold it to the shaft and prevent leakage along the pump shaft, and spring tension to maintain proper compression on the seal faces. Chemical compatibility is extensive, as governed by the Viton® elastomer. All metal components of the seal are 316 stainless steel, with a carbon rotary and ceramic seat.

We do not recommend the use of either of these seals with inherently abrasive materials. However, these seals will handle most liquids over an extremely wide range of temperatures (from -10°F to +250°F for a Type 21 seal and from -10°F to +450°F for a Type 9 seal) and pressures (from 25 inches of mercury vacuum to 150 psig for a Type 21 seal and 250 psig for a Type 9 seal).

NOTE: The specific gravity of a liquid affects successful seal operations. Therefore, any liquid whose specific gravity is less than 0.63 should be considered exceptional. In these cases please consult our Sales Engineering Department.

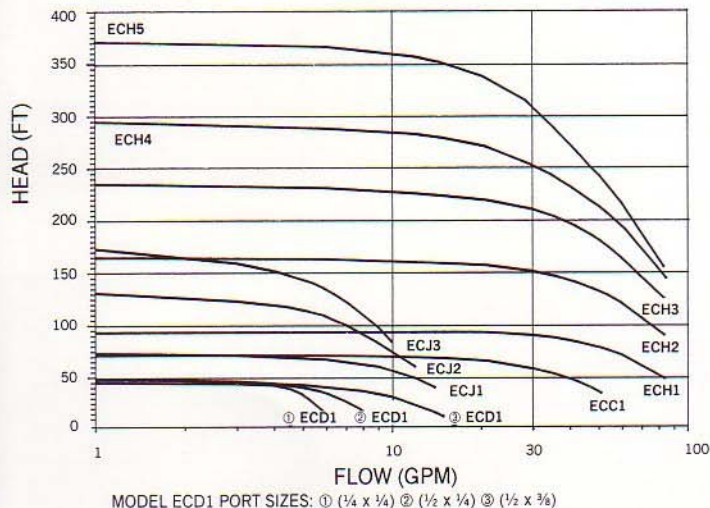

Composite performance

Use this graph to select an Eastern Centrichem pump. Refer to pages 4 through 8 for individual, detailed performance curves of each pump.

General specifications Use this chart in conjunction with the individual performance curves on the following pages. Note: keep this page folded out for easy reference.

Model	Size	Maximum Capacity	TDH (shut off head)	Basic Materials Available*	Mechanical Seals (Internal)
ECD1	1/4" suction 1/4" discharge	6.5 gpm	46 ft	316 ss	single
ECD1	1/2" suction 1/4" discharge	9.0 gpm	50 ft	316 ss	single
ECD1	1/2" suction 3/8" discharge	20.0 gpm	50 ft	316 ss	single
ECJ1	1/2" suction 1/2" discharge	20.0 gpm	75 ft	316 ss	single double
ECJ2	1/2" suction 1/2" discharge	16.0 gpm	130 ft	316 ss	single double
ECJ3	1/2" suction 1/2" discharge	15.0 gpm	175 ft	316 ss	single double
ECC1	1" suction 3/4" discharge	54.0 gpm	72 ft	316 ss Alloy C	single double
ECH1	1 1/2" suction 1" discharge	94.0 gpm	93 ft	316 ss Alloy C	single double
ECH2	1 1/2" suction 1" discharge	94.0 gpm	165 ft	316 ss Alloy C	single double
ECH3	1 1/2" suction 1" discharge	94.0 gpm	235 ft	316 ss Alloy C	single double
ECH4	1 1/2" suction 1" discharge	94.0 gpm	297 ft	316 ss Alloy C	single double
ECH5	1 1/2" suction 1" discharge	94.0 gpm	365 ft	316 ss Alloy C	single double

*All models are available pickled-and-passivated.

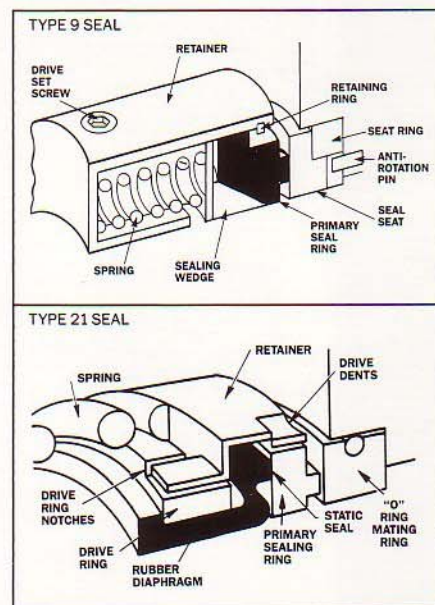

Type 21® and Type 9® are registered trademarks of John Crane International. Teflon® and Viton® are registered trademarks of DuPont.

Single-stage pumps.

The graphs on the following pages depict the performance ranges for our single-stage pumps, based on clean water at 60°F with flooded suction and 3450 RPM motor operating speeds. Graphs for our multi-stage pumps begin on page 6. Minimum recommended continuous flow is calculated as 10% of the Best Efficiency Point (BEP) flow.

ECD1 (Three Models)

ECC1

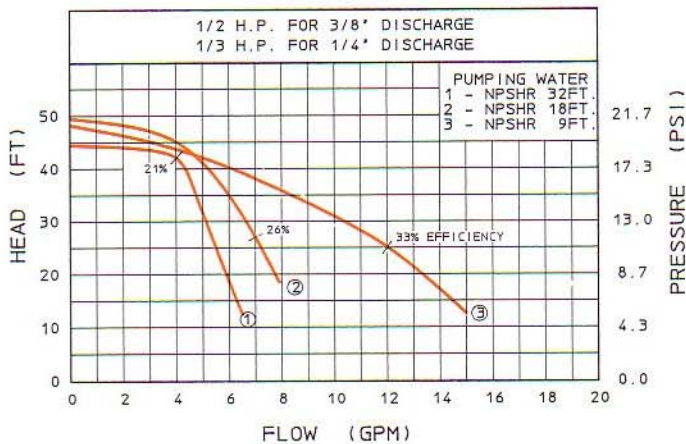
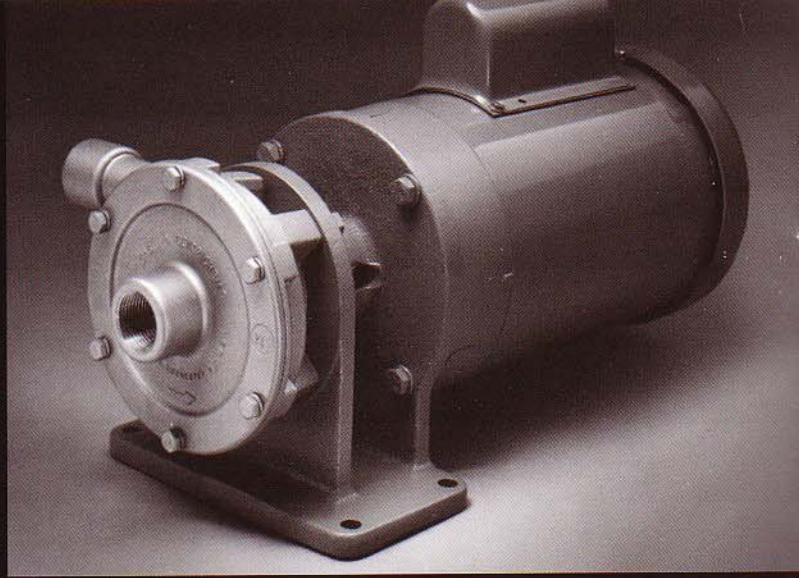
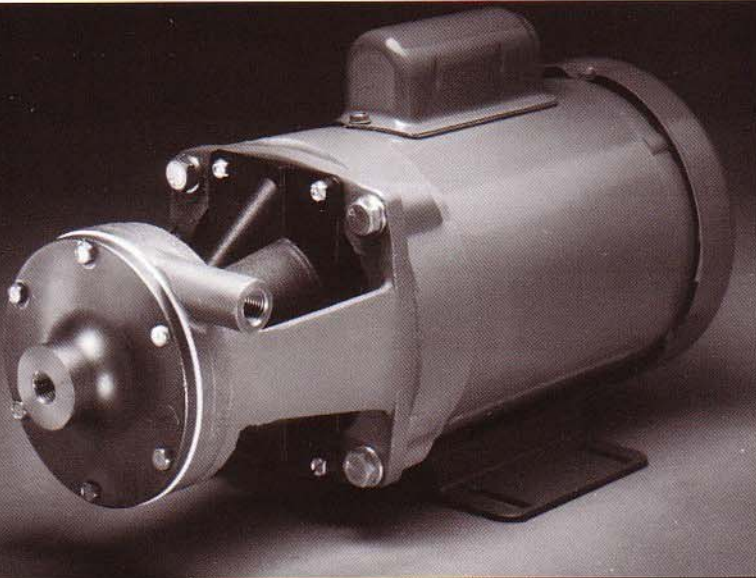

- MODEL ECD1 PORT COMBINATION:
- 1 - 1/4" SUCTION X 1/4" DISCHARGE.
 - 2 - 1/2" SUCTION X 1/4" DISCHARGE.
 - 3 - 1/2" SUCTION X 3/8" DISCHARGE.

Applications: For continuous-duty pilot plant, laboratory, and light industrial services. These pumps will handle a variety of liquids (including solvents and corrosive alkali and acid solutions) at modest flow rates and pressures.

Design: These compact pumps employ open impellers and are close-coupled to the motor drives with cast iron brackets. Consult factory for metric motor adapters.

Seal: Type 21[®] mechanical rotary seals with carbon, Viton and ceramic are standard. Type 9[®] seals with chemical-grade carbon, Teflon[®] and silicon carbide are optional.

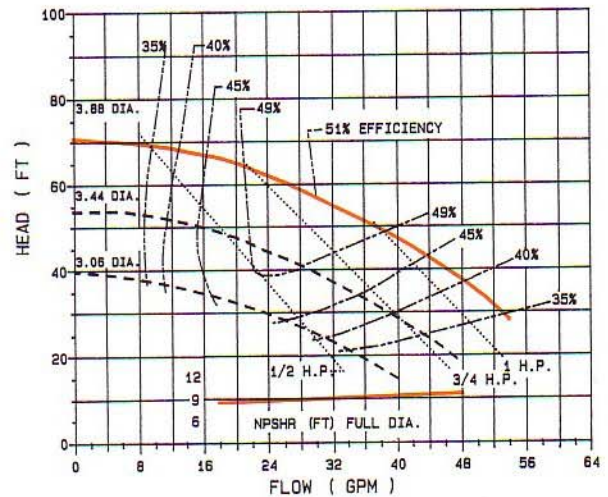

Applications: For continuous-duty general industrial transfer or recirculation of corrosive liquids.

Design: End suction with semi-open impeller close-coupled to mount to any standard 56C motor. Pumps incorporate Teflon[®] O-ring seals and will provide smooth stable operation over the entire flow curve. Consult factory for metric motor adapters.

Seal: Type 21[®] mechanical rotary seals with carbon, Viton, and ceramic are standard on all 316 stainless steel pump models. Type 9[®] seals with chemical-grade carbon, Teflon[®] and silicon carbide are optional on 316 stainless steel models and standard on Alloy C models. Double Type 9[®] seals are available in the same materials.

ECD1		General specifications								ECC1	
Model	Alloy	Inlet	Outlet	Best Eff. Point (BEP)	Max. Flow (GPM)	Shut-off Head (FT)	HP Range	Speed (RPM)	Weight (Pump & Adaptor)	NOTE: Single Seal—6.31" Double Seal—7.62"	
ECD1	316 ss	1/4" FNPT	1/4" FNPT	4 GPM at 42 ft	6.5	46	1/3	3450	7 lbs		
ECD1	316 ss	1/2" FNPT	1/4" FNPT	7 GPM at 27 ft	9	50	1/3	3450	7 lbs		
ECD1	316 ss	1/2" FNPT	3/8" MNPT	12 GPM at 25 ft	20	50	1/2	3450	7 lbs		
ECC1	316 ss and Alloy C	1" FNPT	3/4" FNPT	30 GPM at 58 ft	54	72	3/4 to 1 1/2	3450	25 lbs		

Motor dimensions vary by manufacturer—consult manufacturer's drawing for specifics.

Single-stage pumps.

ECJ1

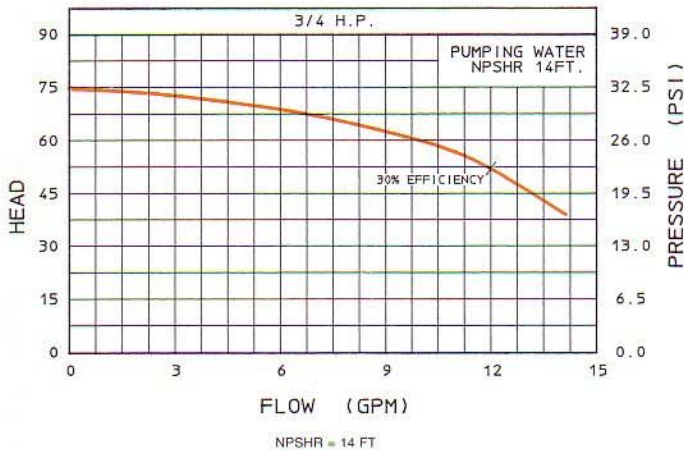
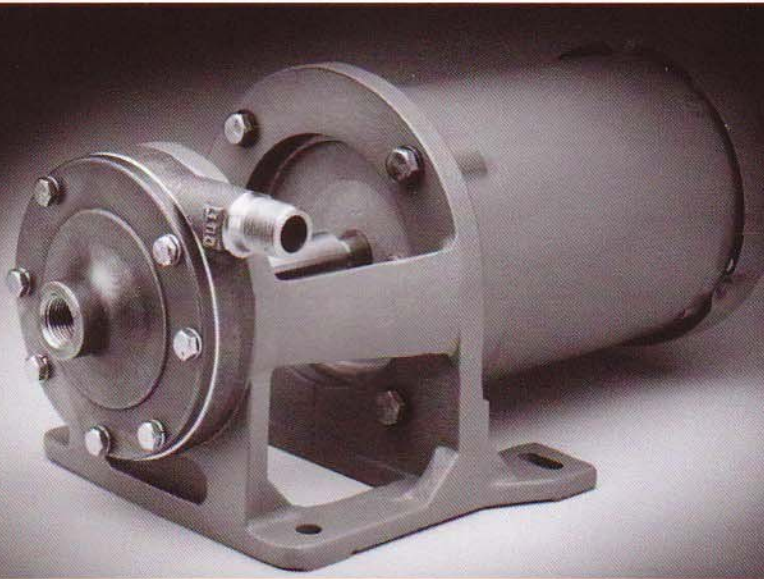

Applications: For continuous-duty industrial transfer, OEM equipment, pilot plant operations, or laboratory use where high purity or corrosive service is needed.

Design: End suction with an open impeller close-coupled to mount to any standard 56C motor. Consult factory for metric motor adaptors.

Seal: Type 21 mechanical rotary seals with carbon, Viton and ceramic are standard on the single or double configurations. Type 9 single seals with chemical-grade carbon, Teflon® and silicon carbide are optional.

ECH1

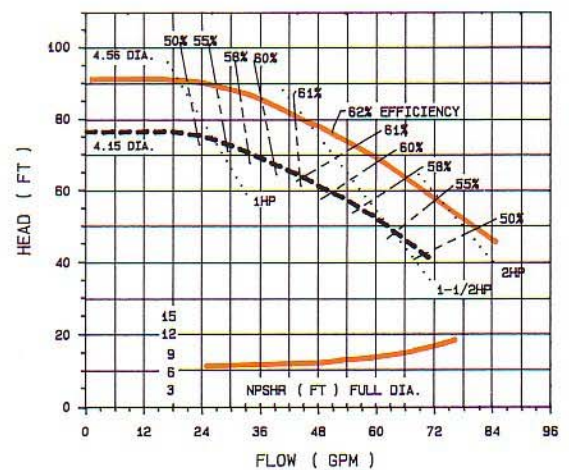
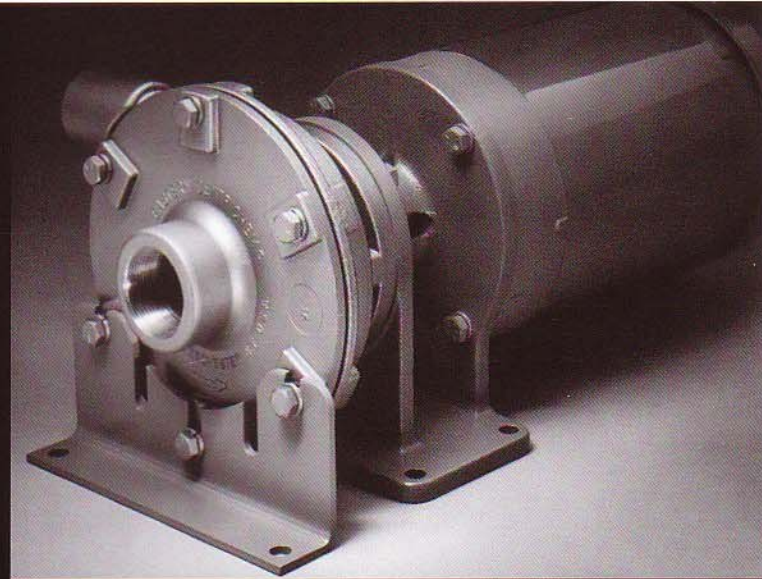

Applications: For continuous heavy-duty industrial transfer or process service where corrosion resistance is needed.

Design: High-efficiency, low-NPSHR end suction with a closed impeller close-coupled to mount to any standard 56C motor. Teflon® O-ring seals. Impeller and housing are precision cast for high strength, chemical resistance, and a smooth internal finish. This results in quiet operation and a non-pulsating fluid flow. Consult factory for metric motor adaptors.

Seal: Type 21 mechanical rotary seals with carbon, Viton, and ceramic are standard on all 316 stainless steel pump models. Type 9 seals with chemical-grade carbon, Teflon® and silicon carbide are optional on 316 stainless steel models and standard on Alloy C models. Double Type 9 seals are available in the same materials.

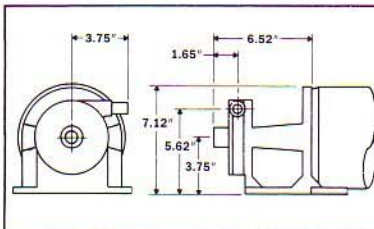

General specifications

Model	Alloy	Inlet	Outlet	Best Eff. Point (BEP)	Max. Flow (GPM)	Shut-off Head (FT)	HP Range	Speed (RPM)	Weight (Pump & Adaptor)
ECJ1	316 ss	1/2" FNPT	1/2" MNPT	12 GPM at 52 ft	20	75	3/4	3450	17 lbs
ECH1	316 ss and Alloy C	1 1/2" FNPT or Flgd	1" FNPT or Flgd	51 GPM at 78 ft	94	93	1 to 2	3450	35 lbs

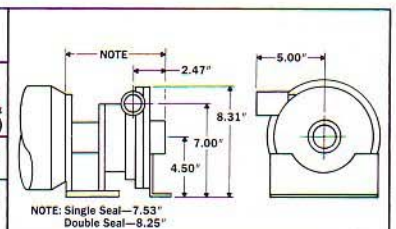

Motor dimensions vary by manufacturer—consult manufacturer's drawing for specifics.

Multi-stage pumps.

The graphs on the following pages depict the performance ranges for our multi-stage pumps, based on clean water at 60°F with flooded suction and 3450 RPM motor operating speeds. You'll find graphs for our single-stage pumps on pages 4 and 5. Minimum recommended continuous flow is calculated as 10% of the Best Efficiency Point (BEP) flow.

ECJ2

ECH2

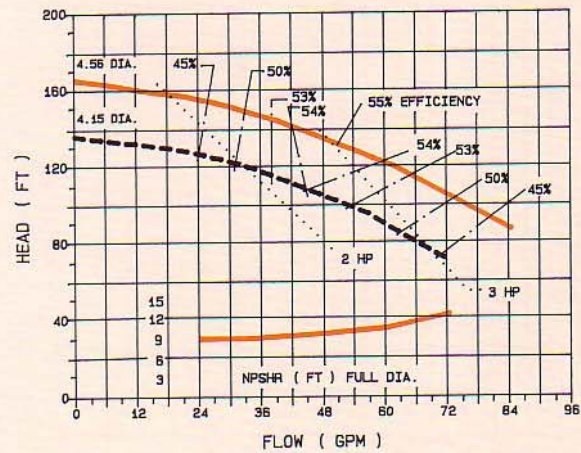
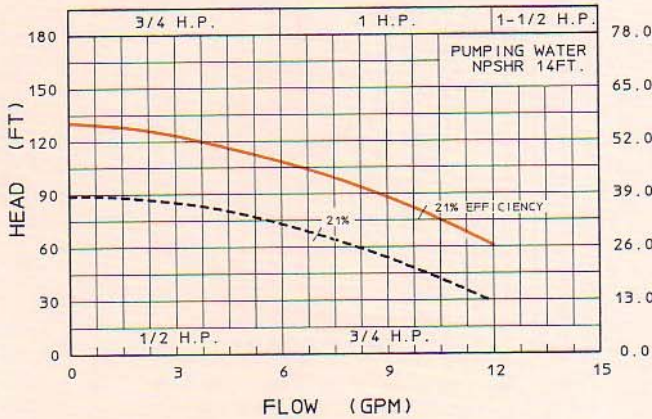
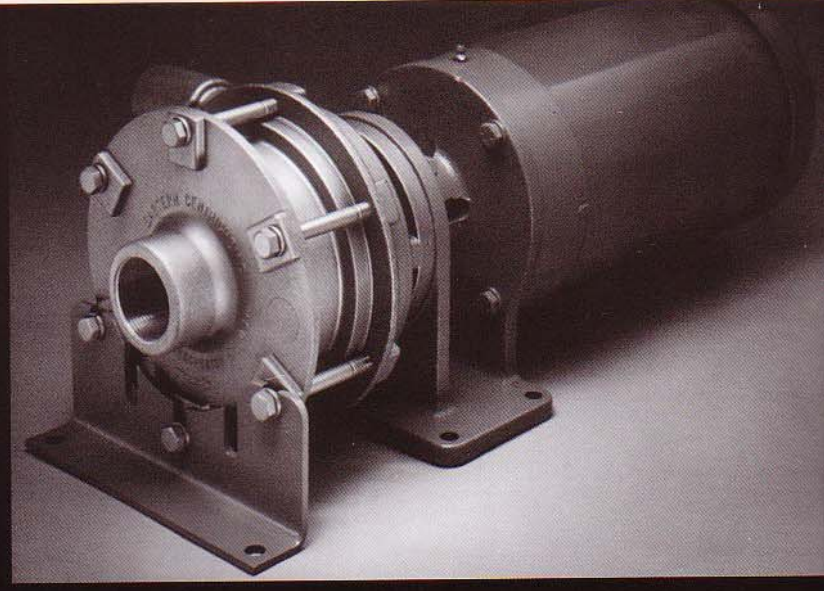
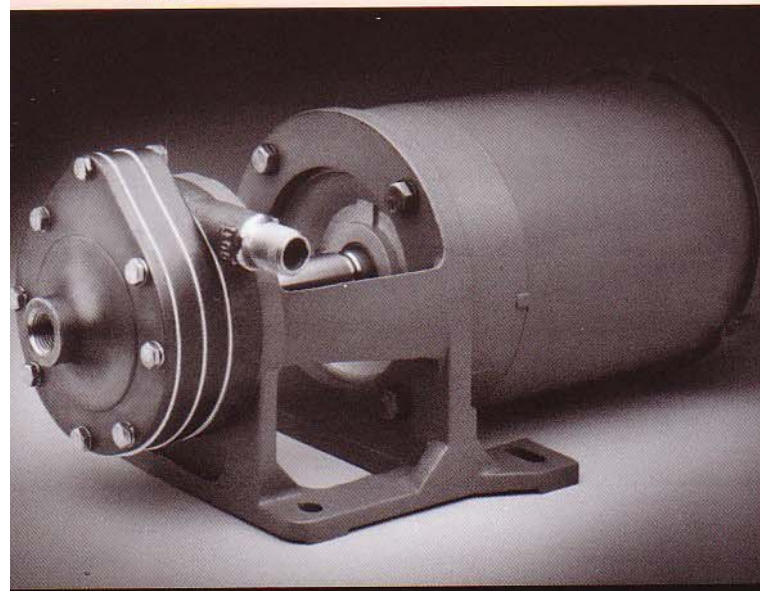

Applications: Continuous-duty, high-pressure pumps are used where positive displacement pumps are normally required, but where liquids containing small particles or solids preclude the use of close tolerance units. For transfer, OEM equipment, pilot plant operations, or laboratory use where high purity or corrosive service is needed.

Design: End suction with an open impeller close-coupled to mount to any standard 56C motor. Consult factory for metric motor adapters.

Seal: Type 21 mechanical rotary seals with carbon, Viton and ceramic are standard on the single or double configurations. Type 9 single seals with chemical-grade carbon, Teflon® and silicon carbide are optional.

Applications: For continuous heavy-duty industrial transfer or process service where corrosion resistance is needed.

Design: High-efficiency, low-NPSHR end suction with a closed impeller close-coupled to mount to any standard 143/5TC or 182/4C motor. Teflon® O-ring seals. These heavy-duty units handle high volumes at high pressures under severe operating conditions. Impellers and stages are precision cast for high strength, chemical resistance, and a smooth internal finish. This results in quiet operation and a non-pulsating fluid flow. Consult factory for metric motor adapters.

Seal: Type 21 mechanical rotary seals with carbon, Viton, and ceramic are standard on all 316 stainless steel pump models. Type 9 seals with chemical-grade carbon, Teflon® and silicon carbide are optional on 316 stainless steel models and standard on Alloy C models. Double Type 9 seals are available in the same materials.

Motor dimensions vary by manufacturer—consult manufacturer's drawing for specifics.		General specifications								NOTE: Single Seal—9.59" Double Seal—10.31"	
Model	Alloy	Inlet	Outlet	Best Eff. Point (BEP)	Max. Flow (GPM)	Shut-off Head (FT)	HP Range	Speed (RPM)	Weight (Pump & Adaptor)	Diagram showing dimensions: 3.75", 2.84", 7.71", 7.12", 5.62", 3.75", 4.53", 8.31", 7.00", 4.50", 5.00"	
ECJ2	316 ss	1/2" FNPT	1/2" MNPT	10 GPM at 79 ft	16	130	3/4 to 1 1/2	3450	21 lbs		
ECH2	316 ss and Alloy C	1 1/2" FNPT or Flgd	1" FNPT or Flgd	51 GPM at 132 ft	94	165	2 to 5	3450	44 lbs		

Multi-stage pumps.

ECJ3

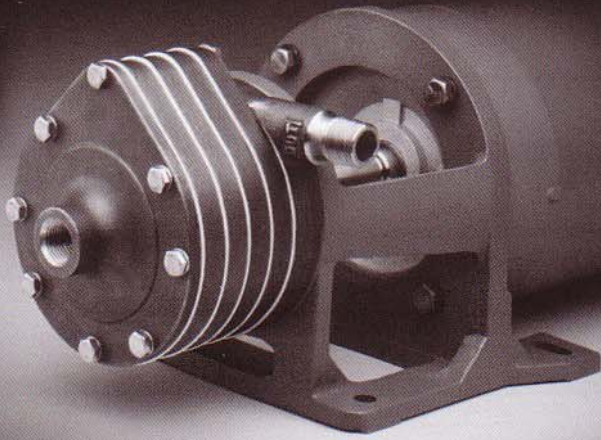

ECH3

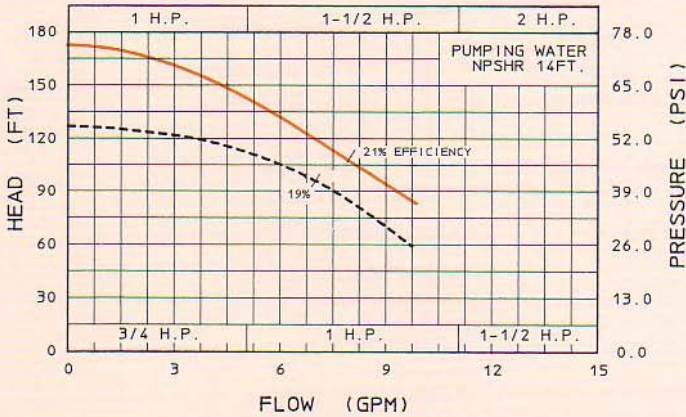
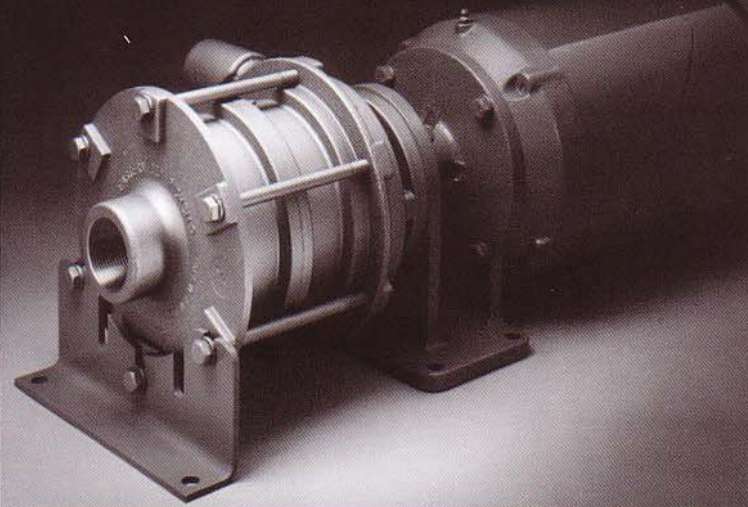

Applications: Continuous-duty, high-pressure pumps are used where positive displacement pumps are normally required, but where liquids containing small particles or solids preclude the use of close tolerance units. For transfer, OEM equipment, pilot plant operations, or laboratory use where high purity or corrosive service is needed.

Design: End suction with an open impeller close-coupled to mount to any standard 56C motor. Consult factory for metric motor adapters.

Seal: Type 21 mechanical rotary seals with carbon, Viton, and ceramic are standard on the single or double configurations. Type 9 single seals with chemical-grade carbon, Teflon® and silicon carbide are optional.

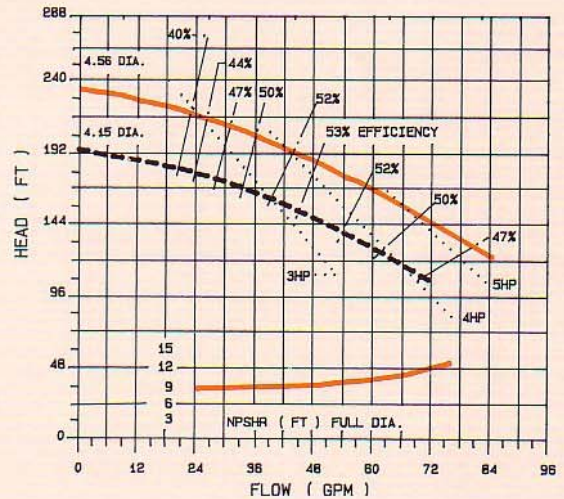

Applications: For continuous heavy-duty industrial transfer or process service where corrosion resistance is needed.

Design: High-efficiency, low-NPSHR end suction with a closed impeller close-coupled to mount to any standard 143/5TC or 182/4C motor. Teflon® O-ring seals. These heavy-duty units handle high volumes at high pressures under severe operating conditions. Impellers and stages are precision cast for high strength, chemical resistance, and a smooth internal finish. This results in quiet operation and a non-pulsating fluid flow. Consult factory for metric motor adapters.

Seal: Type 21 mechanical rotary seals with carbon, Viton, and ceramic are standard on all 316 stainless steel pump models. Type 9 seals with chemical-grade carbon, Teflon® and silicon carbide are optional on 316 stainless steel models and standard on Alloy C models. Double Type 9 seals are available in the same materials.

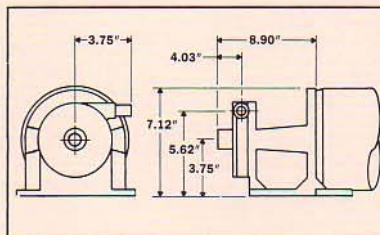

General specifications

Model	Alloy	Inlet	Outlet	Best Eff. Point (BEP)	Max. Flow (GPM)	Shut-off Head (FT)	HP Range	Speed (RPM)	Weight (Pump & Adaptor)
ECJ3	316 ss	1/2" FNPT	1/2" MNPT	8 GPM at 110 ft	15	175	1 to 2	3450	25 lbs
ECH3	316 ss and Alloy C	1 1/2" FNPT or Flgd	1" FNPT or Flgd	48 GPM at 185 ft	94	235	3 to 5*	3450	53 lbs

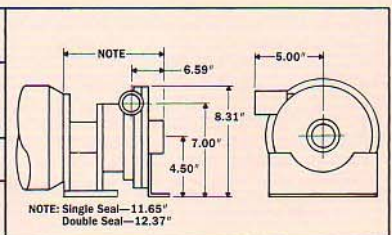

Motor dimensions vary by manufacturer—consult manufacturer's drawing for specifics.

*Requires throttling to 70 GPM.

Multi-stage pumps.

ECH4

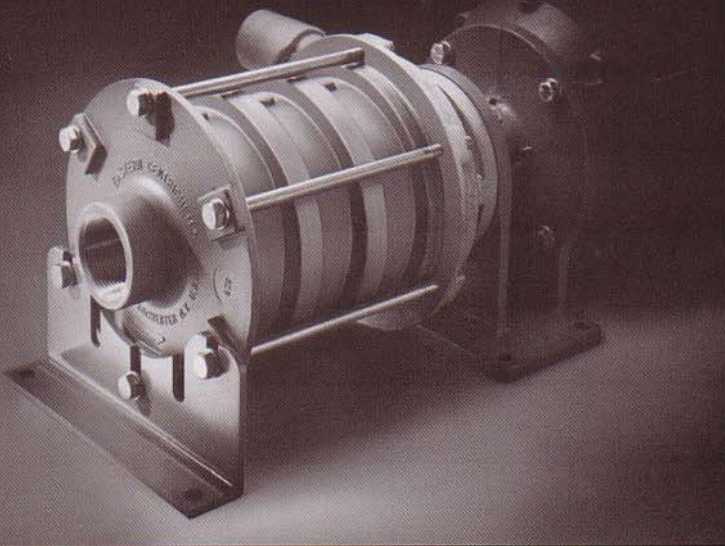

ECH5

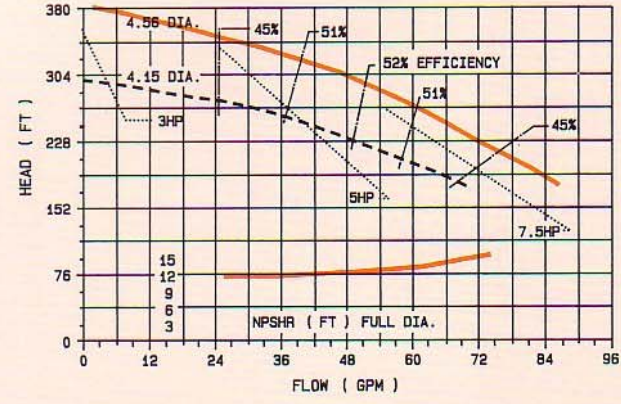
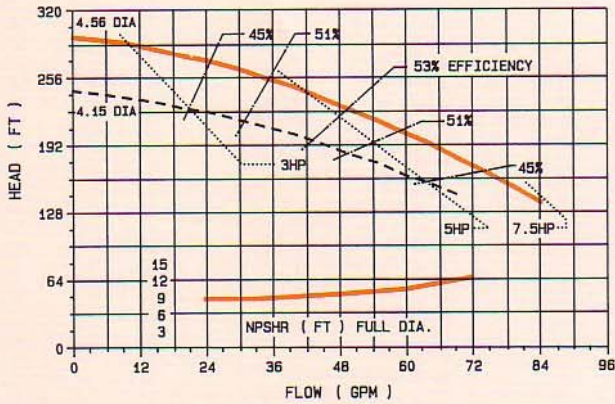
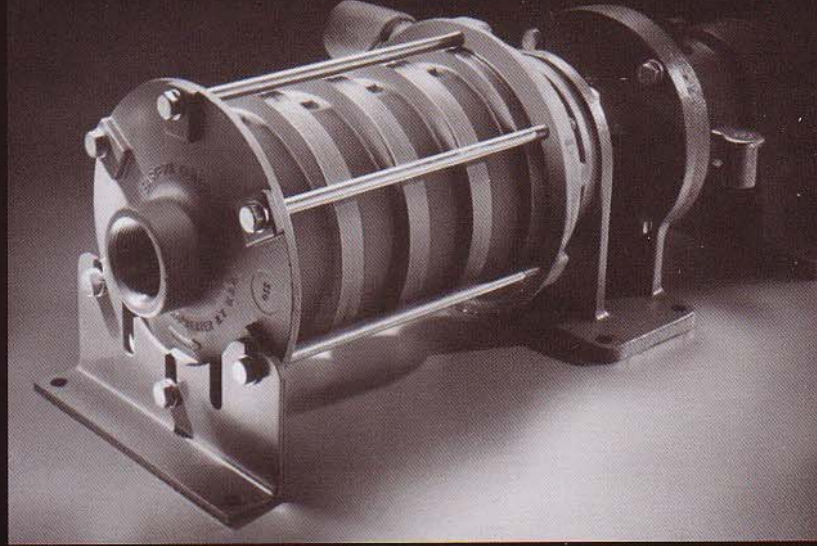

Applications: For continuous heavy-duty chemical transfer or process service where high head and corrosion resistance are required.

Design: High-efficiency, low-NPSHR end suction with a closed impeller close-coupled to mount to any standard 143/5TC or 182/4C motor. Pump is also available power frame mounted. Teflon® O-ring seals. These heavy-duty units handle flows to 94 GPM at high pressures under severe operating conditions. Impellers and stages are precision cast for high strength and chemical resistance. Maximum standardization of parts minimizes and simplifies maintenance. Consult factory for metric motor adapters.

Seal: Type 21 mechanical rotary seals with carbon, Viton and ceramic are standard on all 316 stainless steel pump models. Type 9 seals with chemical-grade carbon, Teflon® and silicon carbide are optional on 316 stainless steel models and standard on Alloy C models. Double Type 9 seals are available in the same materials.

Applications: The Eastern Centrichem 5H Model is rated to 94 GPM with a shut off head of 365 ft., for continuous heavy-duty chemical transfer or process service.

Design: High-efficiency, low-NPSHR end suction with a closed impeller close-coupled to mount to any standard 143/5TC or 182/4C motor. Pump is also available power frame mounted. Teflon® O-ring seals. These heavy-duty units handle high volumes at high pressures under severe operating conditions. Impellers and stages are precision cast for high strength and chemical resistance. Maximum standardization of parts minimizes and simplifies maintenance. Consult factory for metric motor adapters.

Seal: Type 21 mechanical rotary seals with carbon, Viton and ceramic are standard on all 316 stainless steel pump models. Type 9 seals with chemical-grade carbon, Teflon® and silicon carbide are optional on 316 stainless steel models and standard on Alloy C models. Double Type 9 seals are available in the same materials.

		General specifications									
Model	Alloy	Inlet	Outlet	Best Eff. Point (BEP)	Max. Flow (GPM)	Shut-off Head (FT)	HP Range	Speed (RPM)	Weight (Pump & Adaptor)		
ECH4	316 ss and Alloy C	1½" FNPT or Flgd	1" FNPT or Flgd	51 GPM at 225 ft	94	297	5 to 10	3450	62 lbs		
ECH5	316 ss and Alloy C	1½" FNPT or Flgd	1" FNPT or Flgd	51 GPM at 273 ft	94	365	5 to 10	3450	71 lbs		

Motor dimensions vary by manufacturer—consult manufacturer's drawing for specifics.

How to select the right pump identification number.

All Eastern pump identification plates include the basic model number. These numbers fully describe the pump and seal specifications necessary for the future identification of your pump, and the replacement of parts or equipment, as needed.

Look at the sample model number (below) to see what information these numbers contain.

NOTE: Be sure to provide complete nameplate data when you order spare parts or replacement-pump motor assemblies.



Position No. 1 2 3 4 5 6 7 8 9 10 11 12
 Model No. ECJ2-ASACCYSS

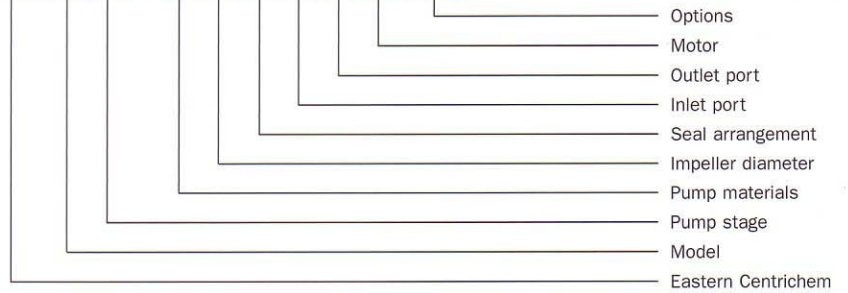

Pump identification number selection table

Position No. 1 & 2	EC = Eastern Centrichem Centrifugal Pump			
Position No. 3	Model	Standard Impeller Diameter		
	C	3.88"		
	D	3.25"		
	H	4.56"		
	J	3.75"		
Position No. 4	Pump Stage	Model		
	1 = Single Stage	C	D	H
	2 = Two Stage	•	•	•
	3 = Three Stage	•	•	•
	4 = Four Stage	•	•	•
	5 = Five Stage	•	•	•
Position No. 5	Available Pump Materials			
	A = 316SS	•	•	•
	B = 316SS (Pickle & Passivate)	•	•	•
	C = Alloy C	•	•	•
Position No. 6	Impeller Diameter			
	S = Standard Impeller	•	•	•
	A = 3.44"	•	•	•
	B = 3.06"	•	•	•
	C = 4.15"	•	•	•
	F = 3.12" (J2 & J3 Only)	•	•	•
Position No. 7	Seal Arrangements (See Note 4)			
	A = 316SS Single 21 Seal	•	•	•
	CBN Rotary, Ceramic Seat, VTN	See Note 1	•	See Note 1
	P = 316SS Single 21 Seal	•	•	•
	P90 Rotary, Silicon CBD Seat, EPR	See Note 1	•	See Note 1
	C = 316SS Double 21 Seal	•	•	•
	(2 Single 21 Seals)	•	•	•
	CBN Rotary, Ceramic Seat, VTN	•	•	•
	K = 316SS Single 9 Seal	•	•	•
	CBN Rotary, Silicon CBD Seat, TFE	•	•	•
	T = 316SS Single 9 Seal	•	•	•
	FTF Rotary, Silicon CBD Seat, TFE	•	•	•
	E = 316SS Double 9 Seal	•	•	•
	CBN Rotary, Silicon CBD Seat, TFE	•	•	•
	B = Alloy C Single 9 Seal	•	•	•
	CBN Rotary, Silicon CBD Seat, TFE	•	•	•
	R = Alloy C Single 9 Seal	•	•	•
	FTF Rotary, Silicon CBD Seat, TFE	•	•	•
	F = Alloy C Double 9 Seal	•	•	•
	CBN Rotary, Silicon CBD Seat, TFE	•	•	•
Position No. 8	Inlet Port			
	A = 1/4" FNPT	•	•	•
	C = 1/2" FNPT	•	•	•
	E = 1" FNPT	•	•	•
	F = 1 1/2" FNPT	•	•	•
	M = 1 1/2" 150 lb. Raised-face ANSI Flange	•	•	•
Position No. 9	Outlet Port			
	A = 1/4" FNPT	•	•	•
	C = 1/2" MNPT	•	•	•
	D = 3/4" FNPT	•	•	•
	E = 1" FNPT	•	•	•
	G = 3/8" MNPT	•	•	•
	L = 1" 150 lb. Raised-face ANSI Flange	•	•	•
Position No. 10	Motor (See Note 3)			
	Y = Pump and Motor	•	•	•
	N = Pump Wet End Only	•	•	•
Position No. 11 & 12	Options			
	SS = No Options	•	•	•
	AX = Vents and Drains	•	•	•
	BX = Seal Flushing Port(s) (Note 2)	•	•	•
	CX = Vents, Drains and Seal Flushing Port(s)	•	•	•

Note 1:
316SS Single 21 Seal is not available for C & H Series pumps in Alloy C construction (Pump material option C)

Note 2:
Seal flushing ports are standard for all pumps with double seals and Model H pumps with single Type 9 Seals

Note 3:
Power frame or 5 HP motor option is required when selecting H4 or H5 models.

Note 4:
Max. discharge pressure for Type 21 seals is 200 psig.

Eastern Express Delivers the pumps you need when you need them.

Our new Regional Stocking and Service Distributors are ready to deliver *now*. They'll give you prompt, technical service with "off the shelf" solutions to your pumping needs.

Call your local Eastern distributor today for the pumps, parts, and service you need.



PULSAFEEDER
A Unit of IDEX Corporation

Manufacturers of Quality Pumps,
Controls and Systems

2883 Brighton-Henrietta Town Line Road
Rochester, New York 14623
(585) 292-8000
Telefax (585) 424-5619
<http://www.pulsa.com>



IDEX
IDEX CORPORATION

