

Isochem[®]

**Magnetic centrifugal and gear pumps
for leak-free service.**

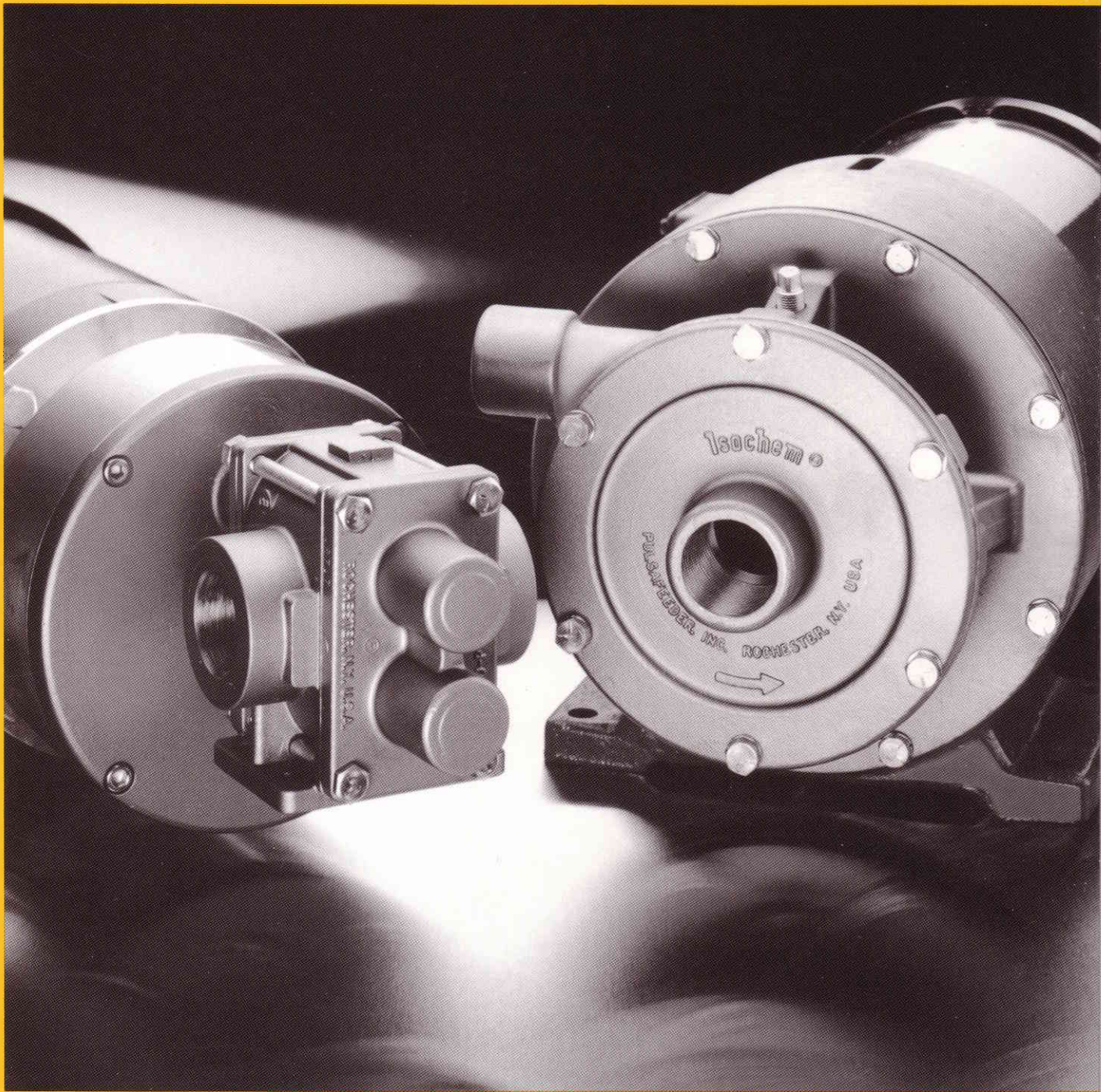

PULSAFEEDER
A Unit of IDEX Corporation

Isochem[®]

For Economical Leak-Free Service

Centrifugal-Magnetic Coupling

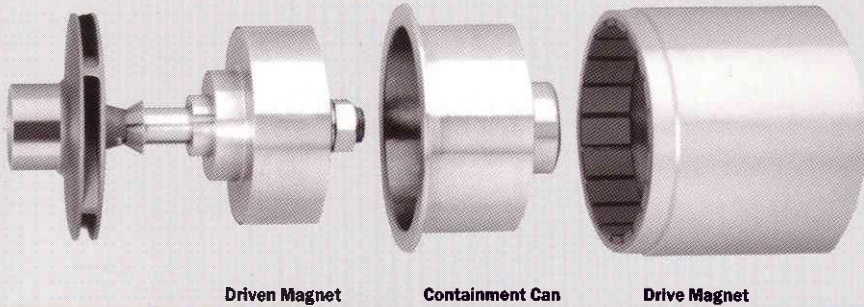

Driven Magnet

Containment Can

Drive Magnet

Gear-Magnetic Coupling

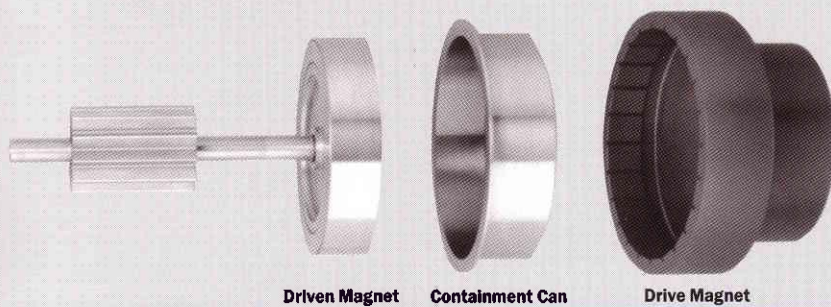

Driven Magnet

Containment Can

Drive Magnet

COUPLING DESIGN PRINCIPLE

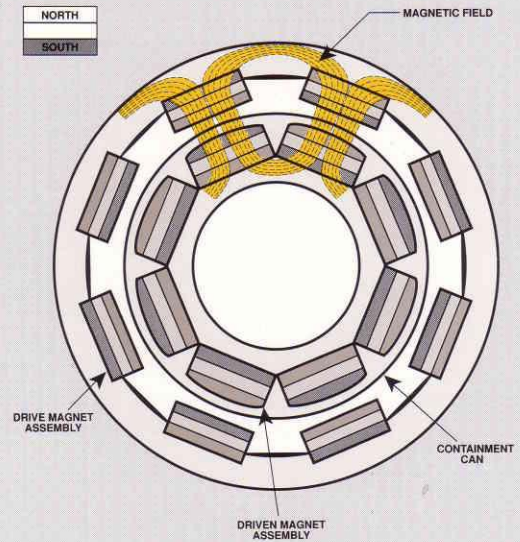

Engineered For Environmental Safety.

Pulsafeeder's Isochem pumps safely handle hazardous, highly corrosive, explosive or toxic chemicals. They provide safe, leak-free service because the magnetic coupling eliminates the need for traditional sealing methods, such as mechanical seals or packing, the main source of leakage problems on pumps. As a result, downtime and maintenance costs are greatly reduced. And there are no worn seals to replace.

Isochem pumps are offered in two different designs, centrifugal and positive displacement gear type, providing extensive capabilities. The CM Series of centrifugal pumps is available as single-or multi-stage units (up to five stages). Our GMC Series gear pumps are ideal for use when you encounter viscosity or suction lift applications. They are available in 316 stainless steel Alloy 20 and Alloy C construction for maximum chemical resistance.

Advanced Magnetic Technology.

State-of-the-art magnetic technology provides a safe and reliable pump for difficult applications. The drive magnet assembly is fixed to the motor shaft. The driven magnet assembly is attached to the pump shaft and rotates when the drive magnet rotates as a result of magnetic force. The high torque capability of the neodymium iron and rare earth samarium cobalt permanent magnets alleviates the possibility of coupling slippage. The 316 SS and Alloy C Can separates the magnetic assemblies and contains the liquid.

Isochem Offers Many Benefits.

- Minimizes exposure of your personnel to hazardous chemicals.
- Eliminates contacting seal faces which are prone to wear and leakage.
- Provides superior corrosion resistance and minimizes heating (due to eddy-current effect) by utilizing an Alloy C Containment Can.
- Eliminates costly seal flush systems required on all pumps with double mechanical seals.
- Reduces downtime and maintenance costs through extended service intervals.
- Eliminates alignment problems inherent in direct-coupled units.

Applications.

Isochem Series pumps offer two principal designs to handle a broad range of applications over wide temperature, viscosity and pressure variations. They are ideal for vacuum service and transfer of expensive, hazardous and/or corrosive chemicals over the entire pH range. Seal-less features make them perfect for environments subject to federal regulations.

Isochem Centrifugal Pumps.

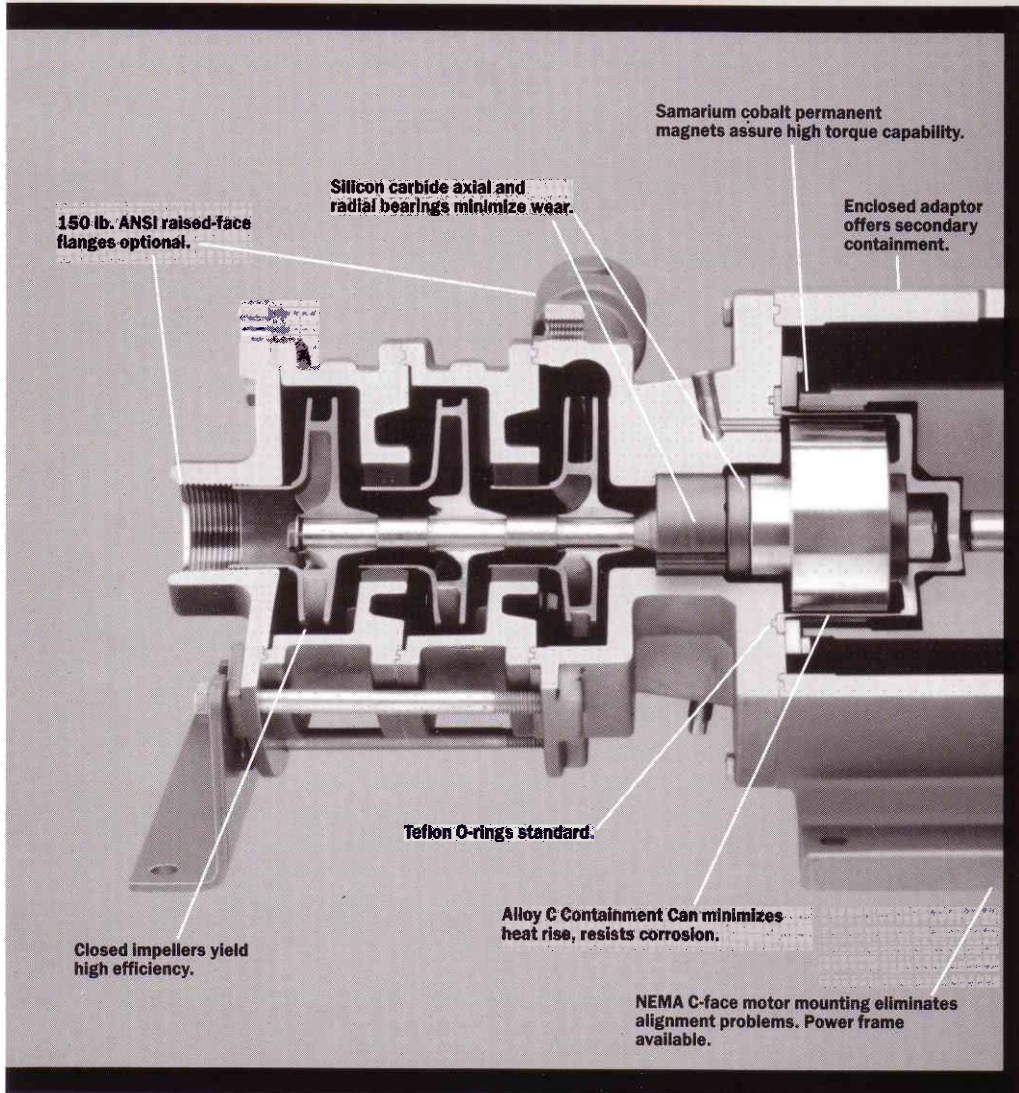

Available in 316 stainless steel, Alloy 20 and Alloy C.

The Isochem centrifugal pump was designed with the user in mind. The features found in the CMC and CMH Series provide the user with a safe, leak-free installation and long operating life.

As illustrated, Isochem centrifugals are designed with the highest quality materials. This helps insure maximum operating life under the most demanding process conditions. For example, our advanced bearing design supporting the magnetic assembly utilizes silicon carbide, providing superior wear and corrosion resistance assuring longer life.

High Efficiency.

Hydraulic efficiency has been raised to a level unmatched in pumps of this size. Precision cast closed impellers and housings reduce flow resistance to a minimum, resulting in lower horse-power requirements.

Operating Limits.

Isochem standard centrifugal pumps are rated at temperatures up to 450°F, and viscosities up to 100 centipoises. For extended application ranges consult your local representative.

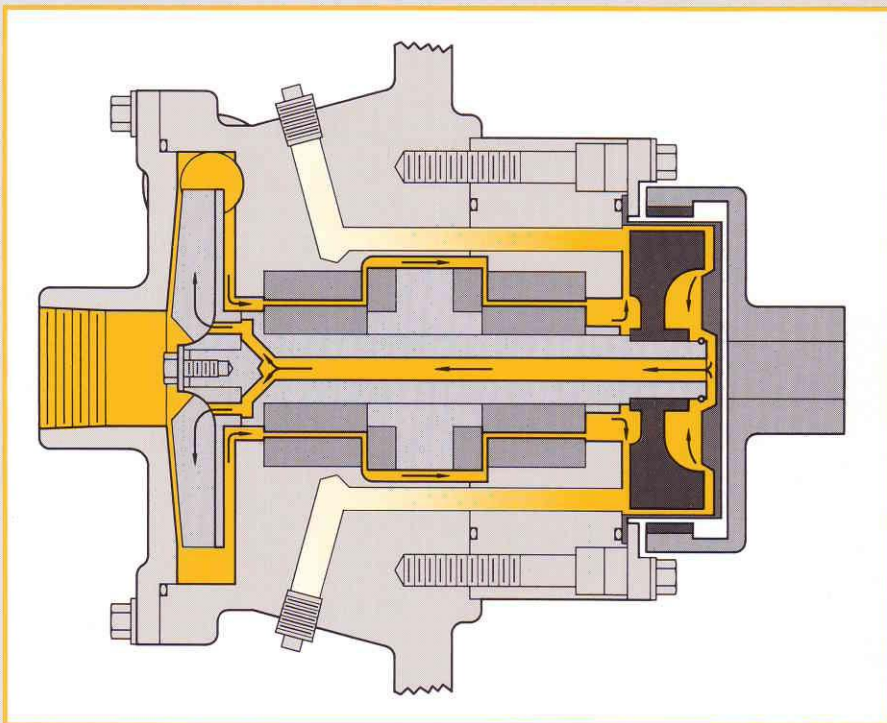

Our unique forced product circulation system lubricates our bearings and provides cooling to alleviate heat rise induced by magnetic eddy-current in the containment can.

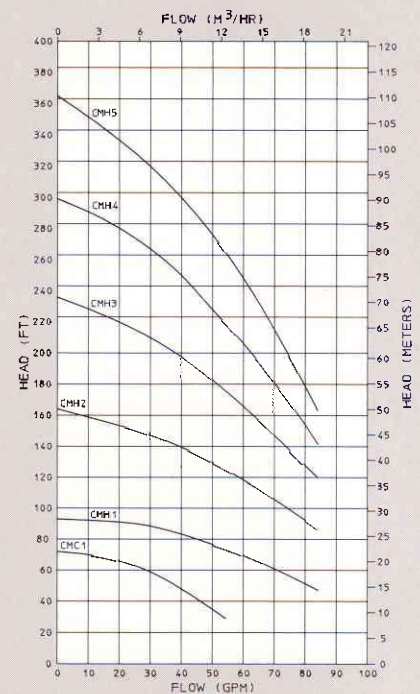

Single-Stage Pumps.

The graphs on the following pages depict the performance ranges of our single-stage or multi-stage pumps based on clean water at 60°F with flooded suction and 3450 r.p.m. motor operating speeds.

CMC1

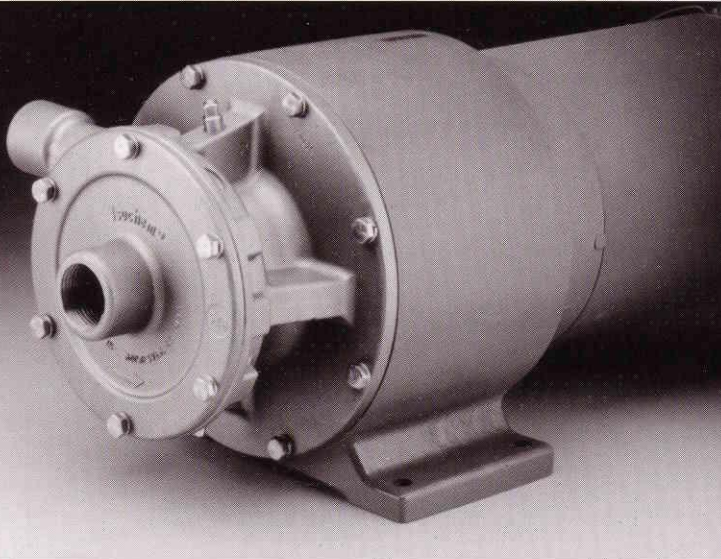

CMH1

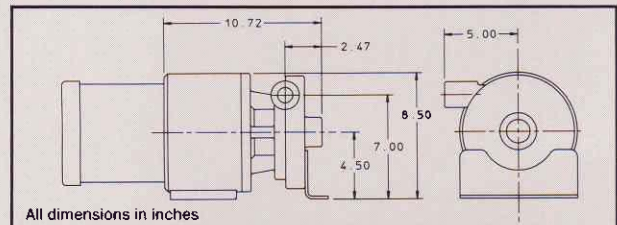
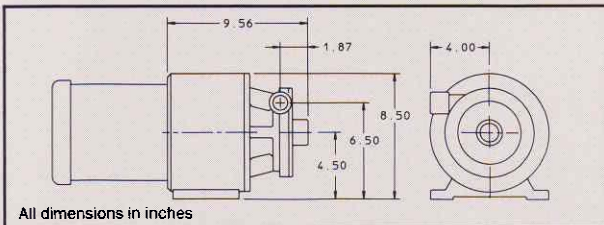
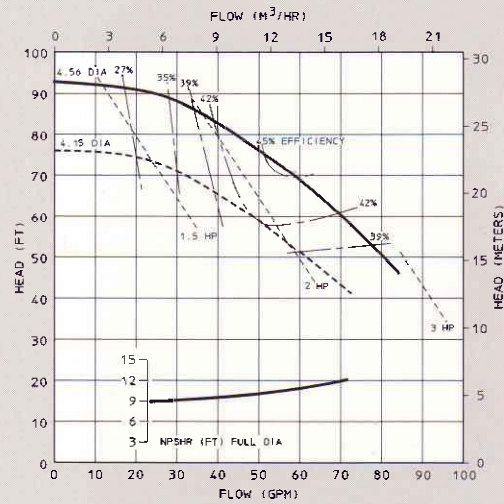
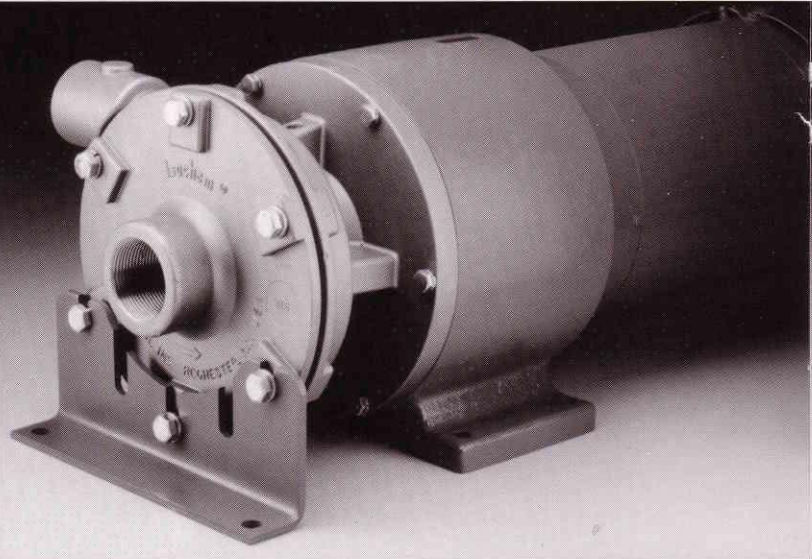

Motor dimensions may vary by manufacturer. Consult manufacturer's drawing for specifics.

General specifications

Model	Alloy	Inlet	Outlet	Best Eff. Point (BEP)	Max. Flow (GPM)	Shut-off Head (FT)	HP Range	Speed (RPM)	Weight (Pump & Adaptor)
CMC1	316 SS, Alloys 20 & C	1" FNPT	3/4" FNPT	30 GPM at 58 ft.	54	72	3/4 to 1 1/2	3450	50 lbs.
CMH1	316 SS, Alloys 20 & C	1 1/2" FNPT	1" FNPT	51 GPM at 78 ft.	94	93	1 1/2 to 3	3450	70 lbs.

Multi-Stage Pumps.

CMH2

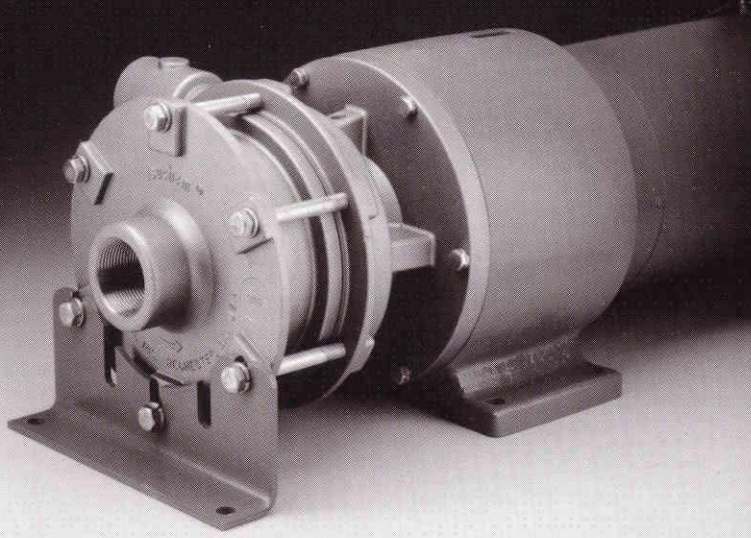

CMH3

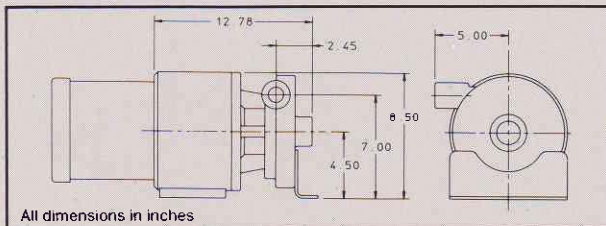
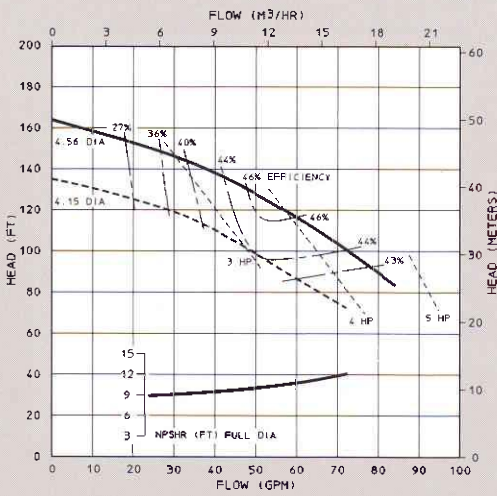
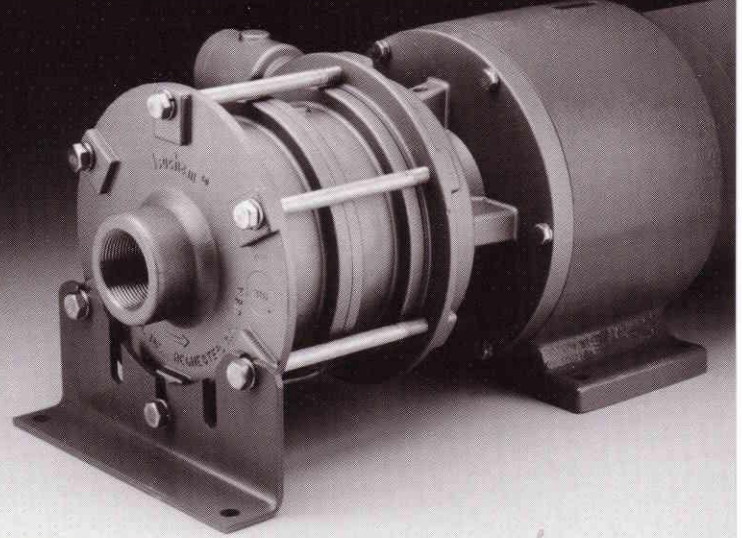

Motor dimensions may vary by manufacturer. Consult manufacturer's drawing for specifics.

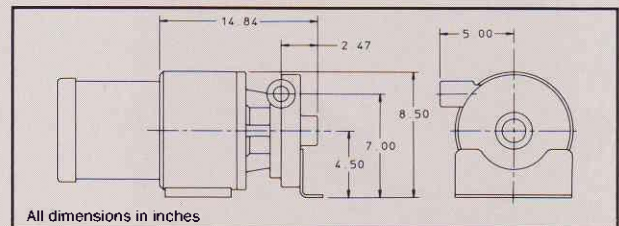
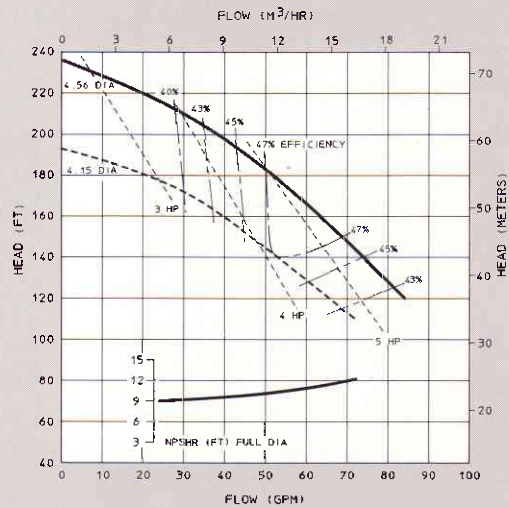

General specifications

Model	Alloy	Inlet	Outlet	Best Eff. Point (BEP)	Max. Flow (GPM)	Shut-off Head (FT)	HP Range	Speed (RPM)	Weight (Pump & Adaptor)
CMH2	316 SS, Alloys 20 & C	1 1/2" FNPT	1" FNPT	51 GPM at 132 ft.	94	165	3 to 5	3450	79 lbs.
CMH3	316 SS, Alloys 20 & C	1 1/2" FNPT	1" FNPT	51 GPM at 178 ft.	94	235	3 to 7 1/2	3450	88 lbs.

Multi-Stage Pumps.

CMH4

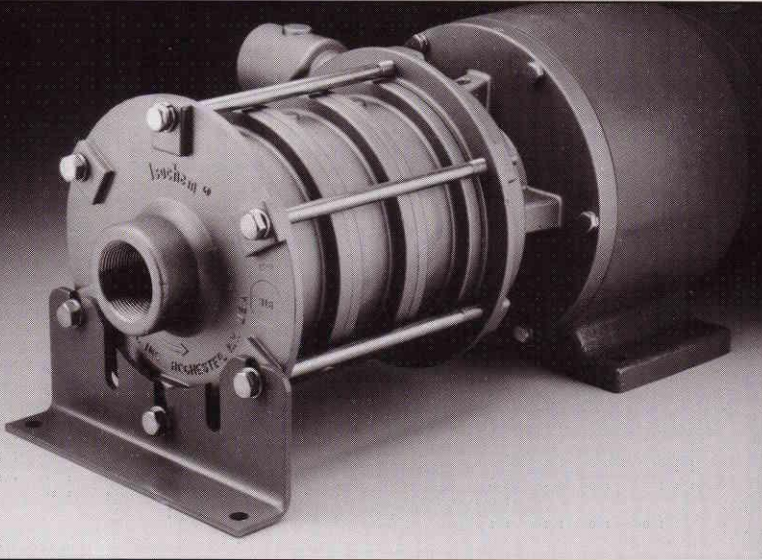

CMH5

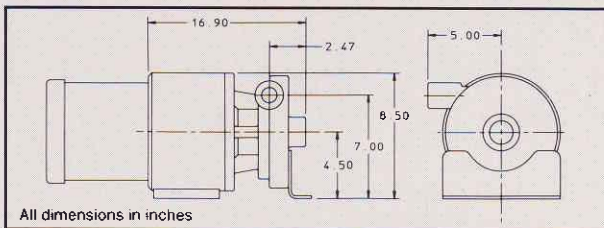
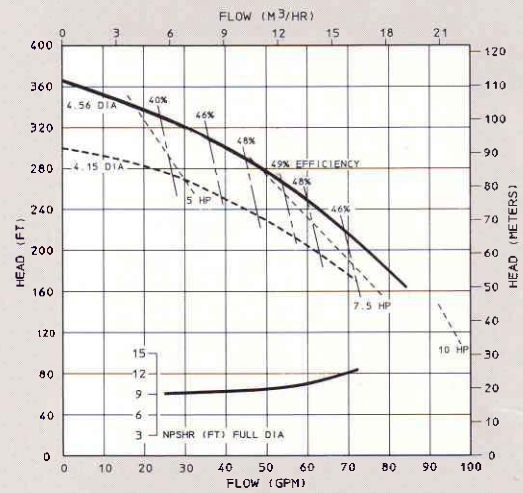
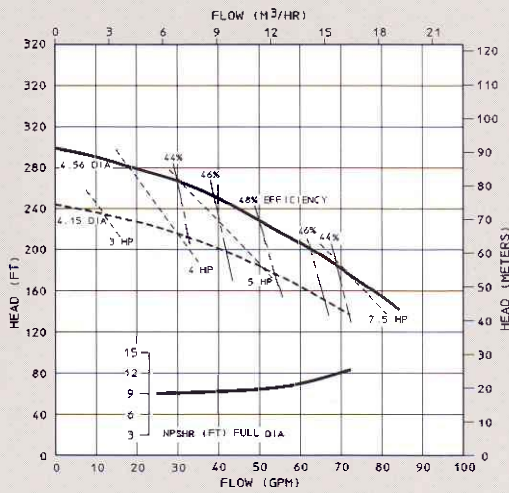
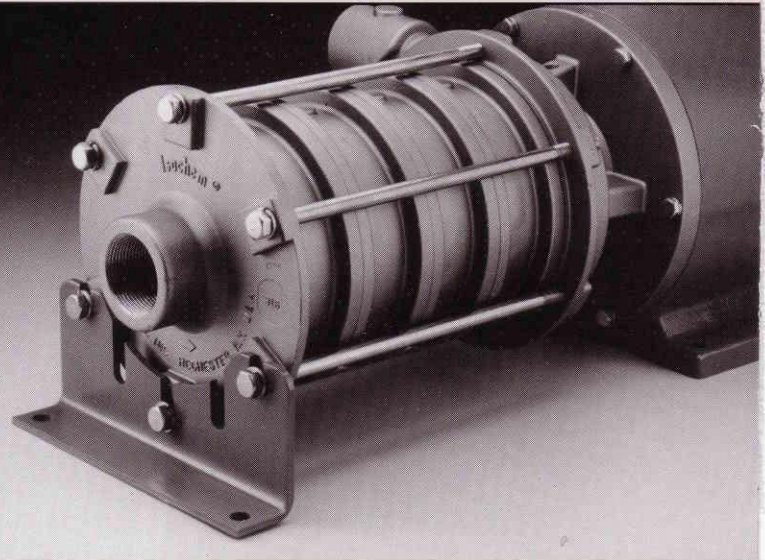

All dimensions in inches

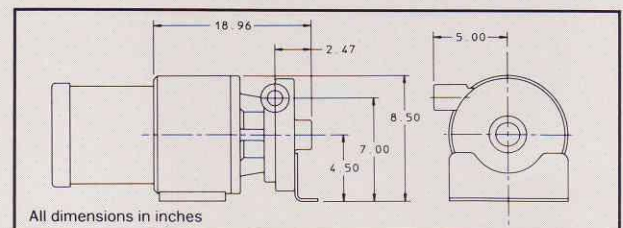

All dimensions in inches

Motor dimensions may vary by manufacturer. Consult manufacturer's drawing for specifics.

General specifications

Model	Alloy	Inlet	Outlet	Best Eff. Point (BEP)	Max. Flow (GPM)	Shut-off Head (FT)	HP Range	Speed (RPM)	Weight (Pump & Adaptor)
CMH4	316 SS, Alloys 20 & C	1 1/2" FNPT	1" FNPT	51 GPM at 225 ft.	94	297	3 to 10	3450	107 lbs.
CMH5	316 SS, Alloys 20 & C	1 1/2" FNPT	1" FNPT	51 GPM at 273 ft.	94	365	5 to 10	3450	116 lbs.

How To Select The Right Pump.

All Isochem pump identification plates include the basic model number. These numbers fully describe the pump specifications necessary for the future identification of your pump, and the replacement of parts or equipment, as needed.

Look at the sample model number (below) to see what information these numbers contain.

Note: Be sure to provide complete nameplate data when you order Spare parts or replacement pump-motor assemblies.

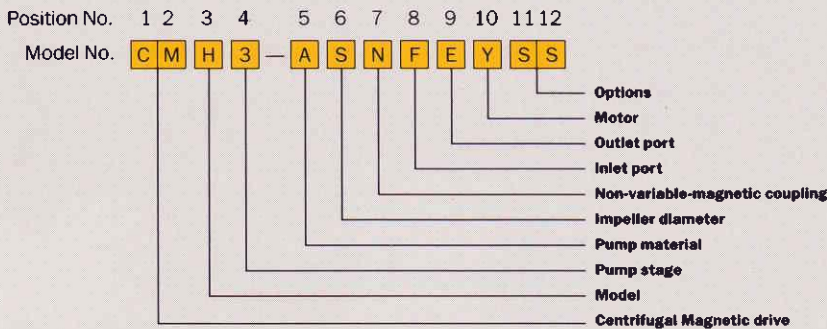
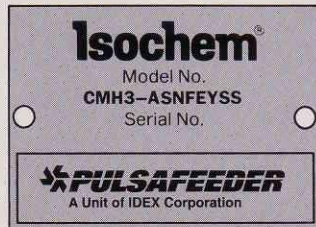

Pump identification number selection table

Position No. 1 & 2	CM = Centrifugal Magnetic drive		
Position No. 3	Model C H	Standard Impeller Diameter 3.88" 4.56"	
Position No. 4	Pump Stage 1 = Single Stage 2 = Two Stage 3 = Three Stage 4 = Four Stage 5 = Five Stage	Model	
		C	H
Position No. 5	Available Pump Materials A = 316SS B = 316SS (Pickle & Passivate) C = Alloy C D = Alloy 20	x	x
Position No. 6	Impeller Diameter S = Standard Impeller A = 3.44" B = 3.06" C = 4.15"	x	x
Position No. 7	N = Non-variable—Magnetic coupling		
Position No. 8	Inlet Port E = 1" FNPT F = 1 1/2" FNPT L = 1" - 150 lb. FLANGE M = 1 1/2" - 150 lb. FLANGE	x	x
Position No. 9	Outlet Port D = 3/4" FNPT E = 1" FNPT K = 3/4" - 150 lb. FLANGE L = 1" - 150 lb. FLANGE	x	x
Position No. 10	Motor Y = Pump and Motor N = Pump Wet End Only	x	x
Position No. 11 & 12*	Options SS = No Options AX = Vents and Drains MA = 140TC Frame Motor Mounting MW = Welded Driven Magnet Assembly	x	x

*Standard mounting arrangement is 56C for CMC and 140 TC for CMH.

Isochem Centrifugal Pump Options.

Pulsafeeder will modify or adapt our pumps to meet severe or unusual service conditions. Also, we can manufacture specialized pumps to meet specific application requirements. Contact your local Isochem representative for assistance in determining what — if any — modifications you need.

In addition to the many standard features offered on the Isochem centrifugal pump, the following are also available:

Power Frame Assembly

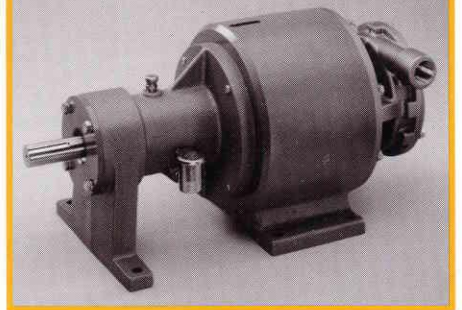

Power Frame Assembly: When NEMA C-flanged motors are not available, or when base mounting is required. The assembly is equipped with single or double row anti-friction bearings.

Flanged Ports

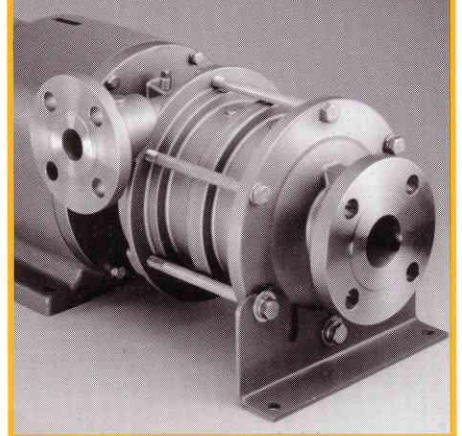

Flanged Ports: Raised-face 150 lb. ANSI flanges are available on the suction and discharge ports of the CMH and CMC models.

Vents and Drains: NPT tapped connections provide easy and safe access for draining or venting product.

Isochem Gear Pumps.

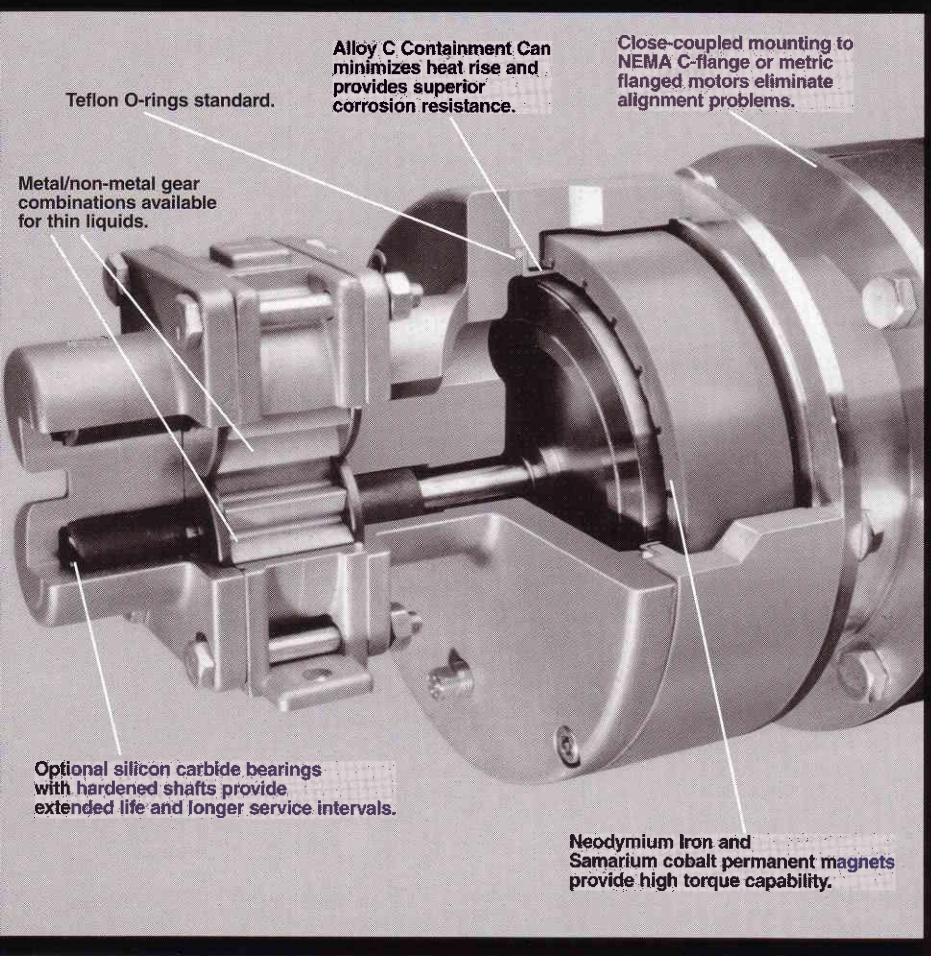

Available in 316 stainless steel, Alloy 20 and Alloy C

The numerous material combinations available make Isochem pumps ideal for continuous duty industrial applications over wide temperature, viscosity and pressure variations. These self-priming pumps yield a constant volume for a particular drive speed and provide linear pulsation-free flows. They depend only upon fluids pumped for cooling, and are designed with component materials which are inherently self-lubricating.

Like the Isochem Centrifugal pump, the Isochem Gear pump incorporates many standard features which allows us to deliver a product that is unsurpassed in quality by other seal-less pump manufacturers.

Isochem gear pumps are easy to maintain. All that is required to inspect the internal components is the removal of a single end plate. Therefore, these pumps can be repaired in the field in a matter of minutes-without removal from your system-because we use completely interchangeable quality-controlled parts.

Dimensional Data
See Back Page

Specifications

			GMC2	GMC4	GMC6	GMC8	GMH6	GMH8	GM12	GM16
Max. flow @ 1750 RPM,	0 pressure	GPM (M3/HR)	1.5 (.34)	3.0 (.68)	10.0 (2.3)	22.0 (5.0)	10.0 (2.3)	22.0 (5.0)	N/A	N/A
Max. flow @ 1150 RPM,	0 pressure	GPM (M3/HR)	1.0 (.23)	2.0 (.45)	6.4 (1.5)	14.5 (3.3)	6.4 (1.5)	14.5 (3.3)	28.0 (6.3)	55.0 (12.5)
Theoretical displacement	GAL/100REV (cc/REV)		.108 (4.08)	.189 (7.15)	.684 (25.89)	1.3687 (51.78)	.684 (25.89)	1.3687 (51.78)	2.792 (105.7)	5.584 (211)
Max. diff. pres.	PSI (BARS)		100 (6.4)	100 (6.9)	100 (6.9)	50 (3.45)	200 (13.8)	100 (6.9)	100 (6.9)	100 (6.9)
Max. diff. pres. plastic/plastic gears	PSI (BARS)		50 (3.45)	50 (3.45)	50 (3.45)	50 (3.45)	N/A	N/A	N/A	N/A
Max. casing pres.			150 (10.3)	150 (10.3)	150 (10.3)	150 (10.3)	250 (17.2)	150 (10.3)	150 (10.3)	150 (10.3)
Temperature Range:										
Metal/metal gears	Samarium (S)		-100 to +450°F (-73 to +232°C)	-100 to +450°F (-73 to +232°C)	-100 to +450°F (-73 to +232°C)	-100 to +450°F (-73 to +232°C)	-100 to +450°F (-73 to +232°C)	-100 to +450°F (-73 to +232°C)	-100 to +450°F (-73 to +232°C)	-100 to +450°F (-73 to +232°C)
Metal/carbon gears										
Metal/peek gears										
Peek/peek gears	(5)									
Metal/plastic gears	(1)		0 to +210°F (-18 to +99°C)	0 to +210°F (-18 to +99°C)	0 to +210°F (-18 to +99°C)	0 to +210°F (-18 to +99°C)	0 to +210°F (-18 to +99°C)	0 to +210°F (-18 to +99°C)	0 to +210°F (-18 to +99°C)	0 to +210°F (-18 to +99°C)
Plastic/plastic gears	(1) (6)									
Temperature Range:										
Metal/metal gears	Neodymium (N)		-100 to +300°F (-73 to +149°C)	-100 to +300°F (-73 to +149°C)	-100 to +300°F (-73 to +149°C)	-100 to +300°F (-73 to +149°C)	N/A	N/A	N/A	N/A
Metal/carbon gears										
Metal/peek gears										
Peek/peek gears	(5)									
Metal/plastic gears	(1)		0 to +210°F (-18 to +99°C)	0 to +210°F (-18 to +99°C)	0 to +210°F (-18 to +99°C)	0 to +210°F (-18 to +99°C)	0 to +210°F (-18 to +99°C)	0 to +210°F (-18 to +99°C)	0 to +210°F (-18 to +99°C)	0 to +210°F (-18 to +99°C)
Plastic/plastic gears (1) (6)										
Max. viscosity	(2)	SSU (CPS)	500000 (100000)	500000 (100000)	500000 (100000)	500000 (100000)	500000 (100000)	500000 (100000)	500000 (100000)	500000 (100000)
Min. viscosity: Metal/metal gears		SSU (CPS)	500 (100)	500 (100)	500 (100)	500 (100)	500 (100)	500 (100)	500 (100)	500 (100)
Min. viscosity: Ceramic wear plates		SSU (CPS)	500 (100)	500 (100)	500 (100)	500 (100)	500 (100)	500 (100)	500 (100)	500 (100)
Max. rotational speed			1750 RPM	1750 RPM	1750 RPM	1750 RPM	1750 RPM	1750 RPM	1150 RPM	1150 RPM
Max. rotational speed: Metal/metal gears			1450 RPM	1450 RPM	1450 RPM	1450 RPM	1450 RPM	1450 RPM	1150 RPM	1150 RPM
Magnetic coupling torque limit @ 68°F		IN/LB (4) (S)	75.6	75.6	214	214	389 (288)	389 (288)	637 (466)	1239 (991)
Magnetic coupling torque limit @ 450°F		IN/LB (4) (S)	60.4	60.4	172	172	341 (252)	341 (252)	558 (434)	1084 (872)
Magnetic coupling torque limit @ 68°F		IN/LB (4) (N)	77.0	77.0	219	219	N/A	N/A	N/A	N/A
Magnetic coupling torque limit @ 300°F		IN/LB (4) (N)	51.5	51.5	146	146	N/A	N/A	N/A	N/A
Inlet port size	NPT, BSPT, 150 LB FLG		1/4 THD	1/2 THD	3/4 THD	1 THD	3/4 THD	1 THD	1 1/2 THD or FLG	2 FLG
Outlet port size	NPT, BSPT, 150 LB FLG		1/4 THD	1/2 THD	3/4 THD	1 THD	3/4 THD	1 THD	1 1/2 THD or FLG	2 FLG
Can drain port size	NPT		1/8 THD	1/8 THD	1/8 THD	1/8 THD	1/8 THD	1/8 THD	1/4 THD	1/4 THD
Bearing type			Internal sleeve	Internal sleeve	Internal sleeve	Internal sleeve	Internal sleeve	Internal sleeve	Internal sleeve	Internal sleeve
Bearing lubrication			By pumped fluid	By pumped fluid	By pumped fluid	By pumped fluid	By pumped fluid	By pumped fluid	By pumped fluid	By pumped fluid
Rotation direction			Reversible	Reversible	Reversible	Reversible	Reversible	Reversible	Reversible	Reversible
Motor frame sizes available			56C, 145TC, 71, 80	56C, 145TC, 71, 80	56C, 145TC, 80, 90	56C, 145TC, 80, 90	143/5TC, 100L	143/5TC, 100L	Any, base mount only	Any, base mount only
Standard sealing material			Teflon	Teflon	Teflon	Teflon	Teflon	Teflon	Teflon	Teflon
Pump and casing HxWxL	(3)	IN	6.50x6.50x7.25	6.50x6.50x7.25	6.75x6.75x8.38	6.75x6.75x8.38	8.88x8.00x12.19	8.88x8.00x13.44	12.19x10x24.56	12.19x10x26.56
Pump and casing weight		LBS (kg)	16 (35.3)	16 (35.3)	28 (61.7)	30 (66.1)	70 (154)	75 (165)	190 (418)	225 (495)

Notes: (1) For temperatures over 110°F trimmed plastic gears are required.

(2) Consult the factory for higher viscosities.

(3) Dimensions vary for metric units, but are within envelope dimensions specified.

(S) Samarium Cobalt magnets.

(4) Torque In () is for double can pumps.

(5) Peek/peek gears are not available on the GMH6, GMH8, GM12 and GM16.

(6) Plastic/plastic gears are not available on the GMH6, GMH8, GM12 and GM16.

(N) Neodymium Iron magnets.

Performance Charts.

GMC2

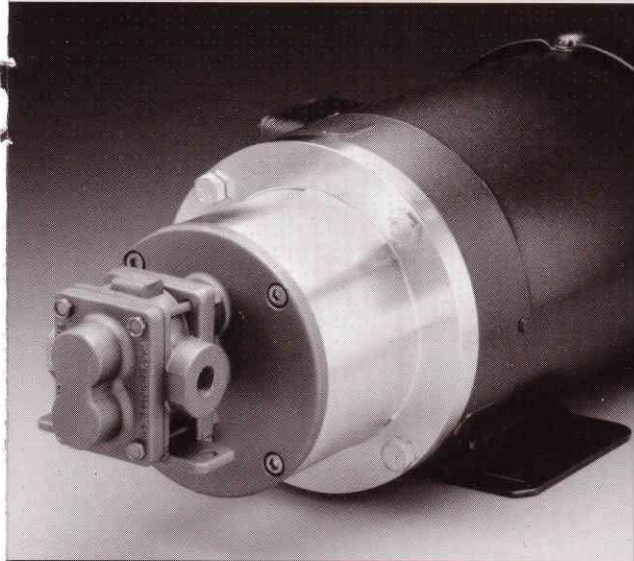

GMC4

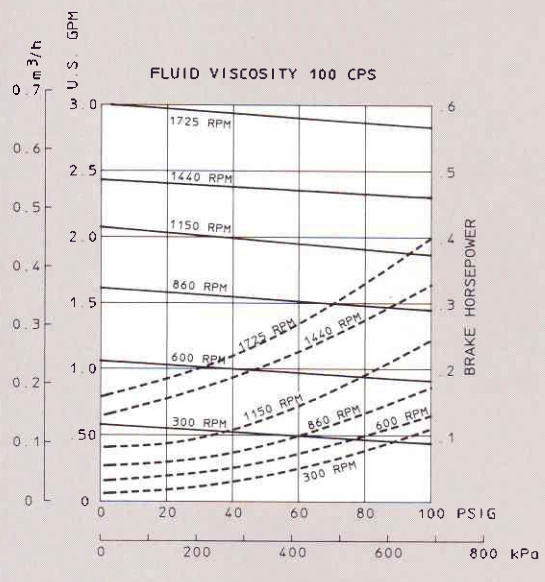
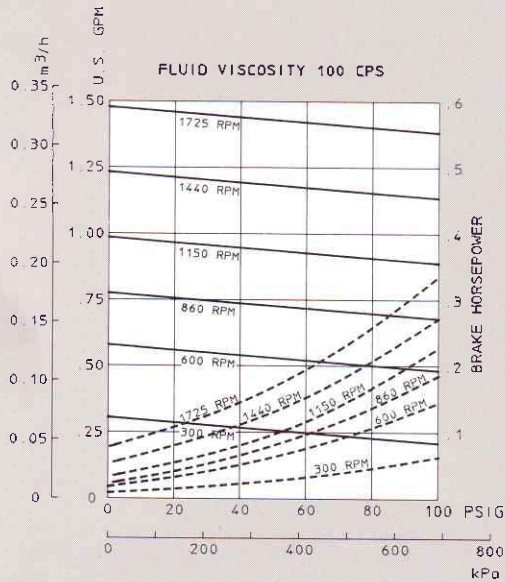
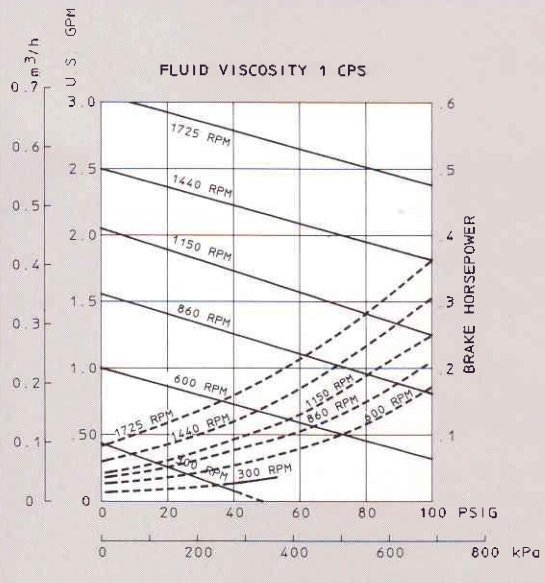
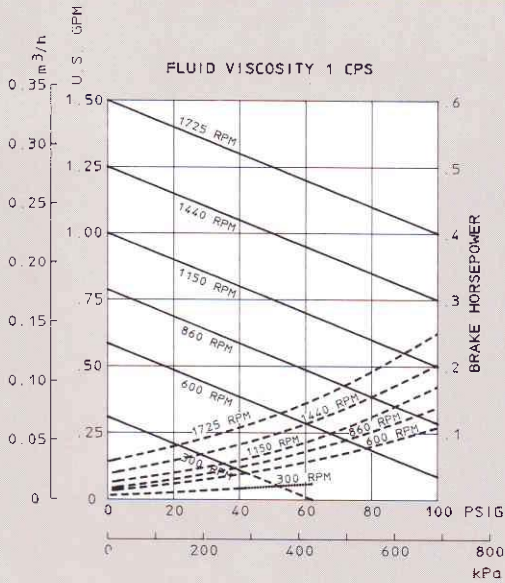
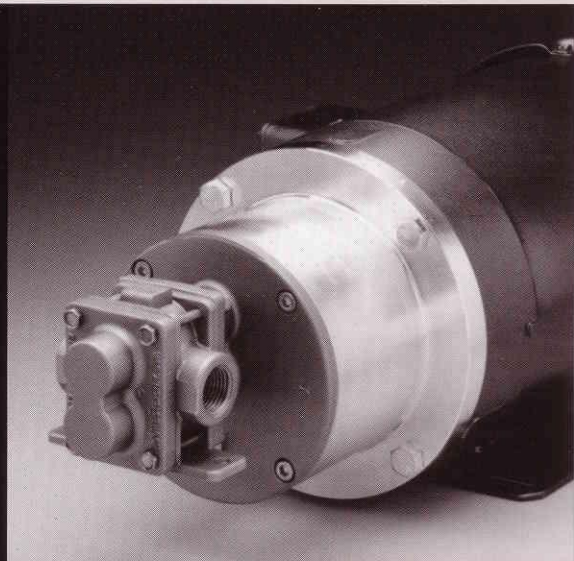

GMC6

GMC8

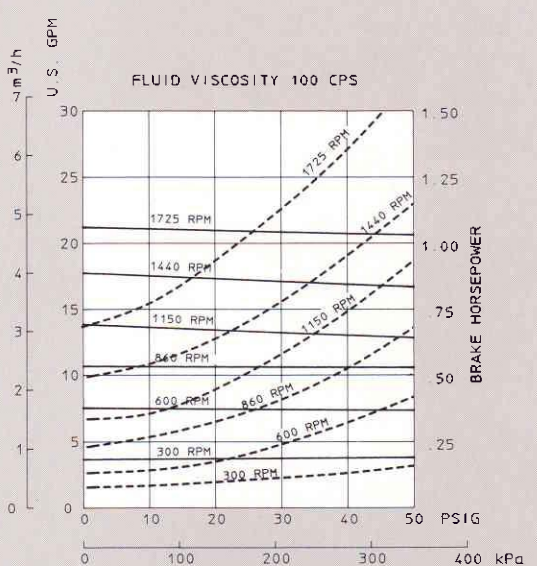
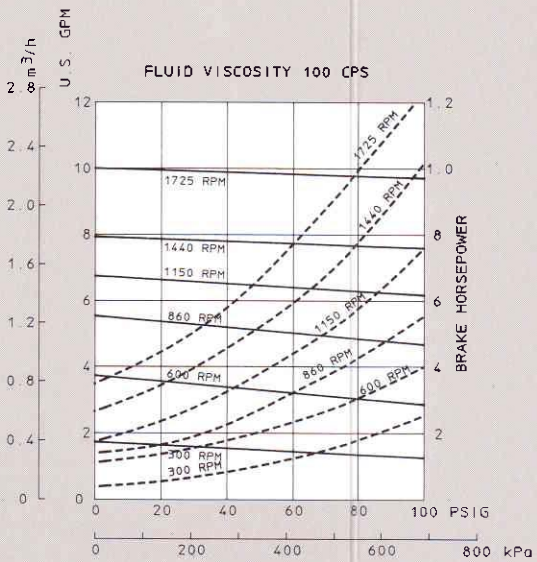
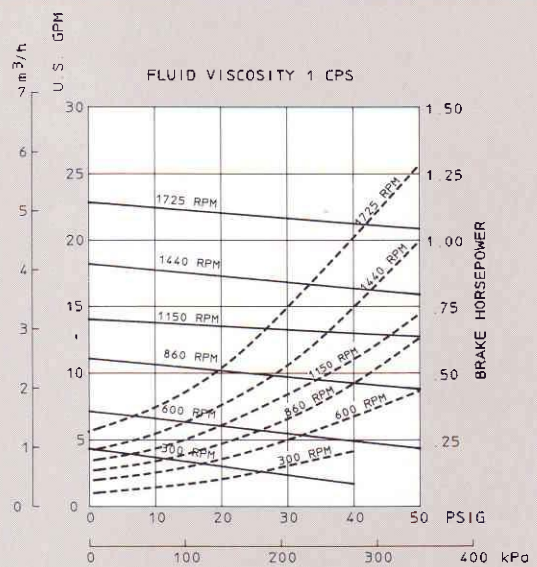
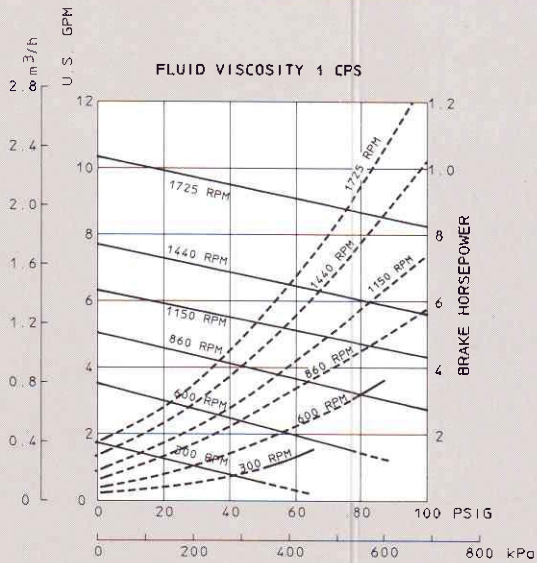
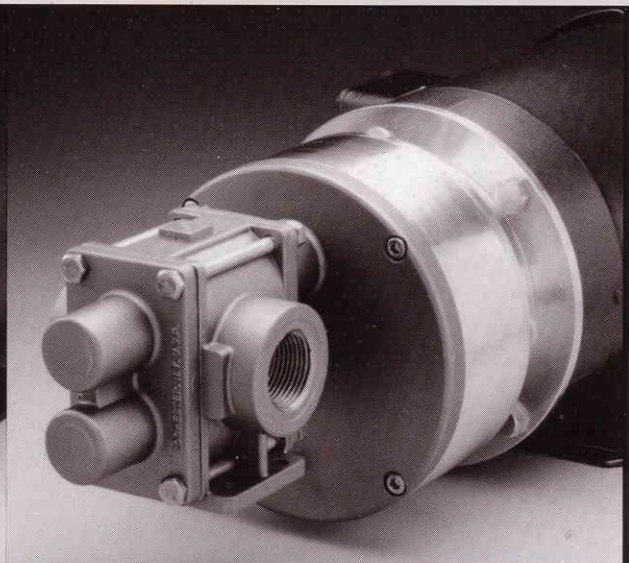
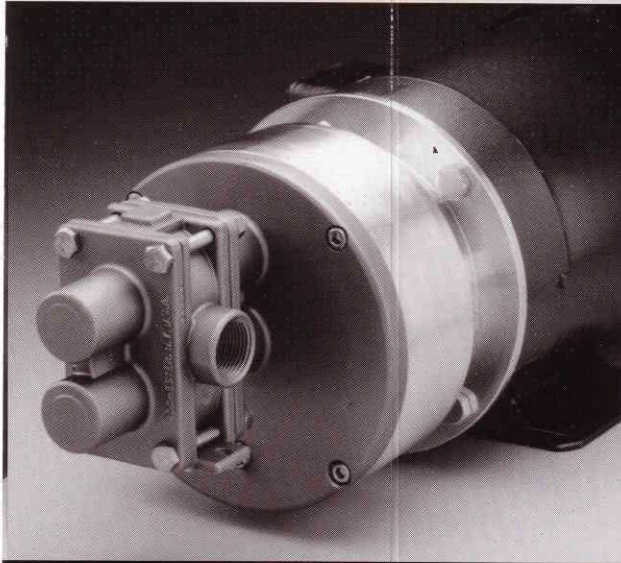

GMC8

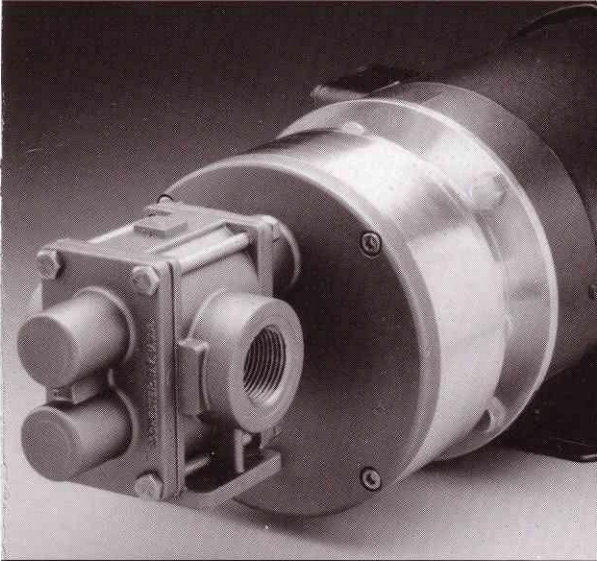

GMH6

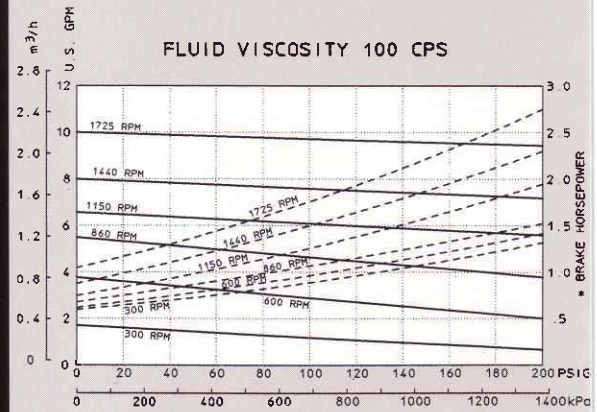
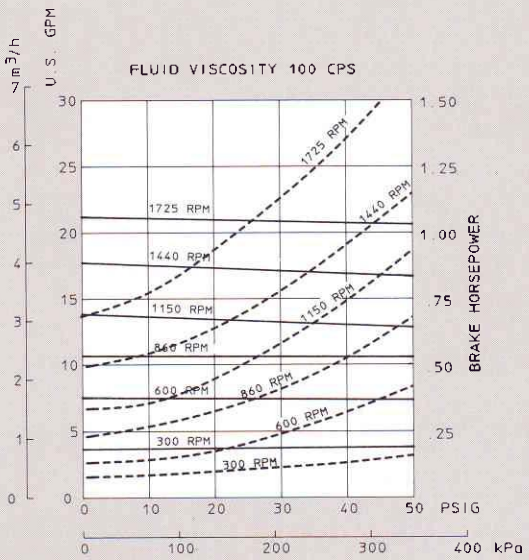
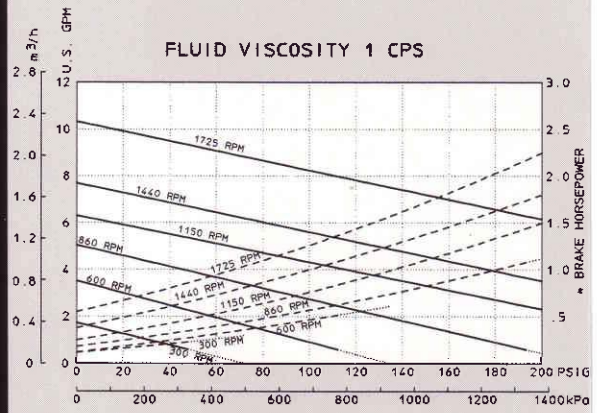
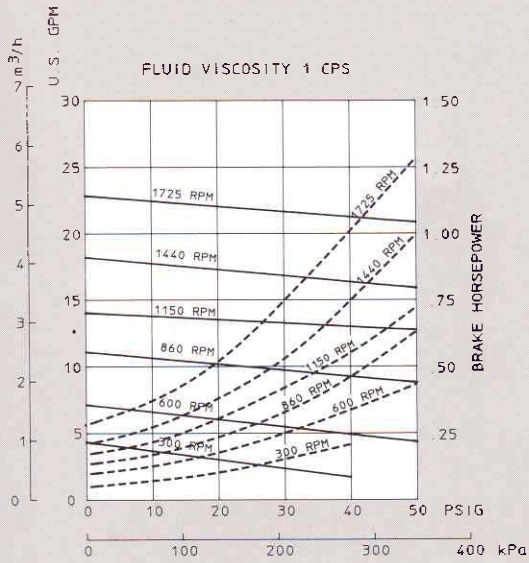
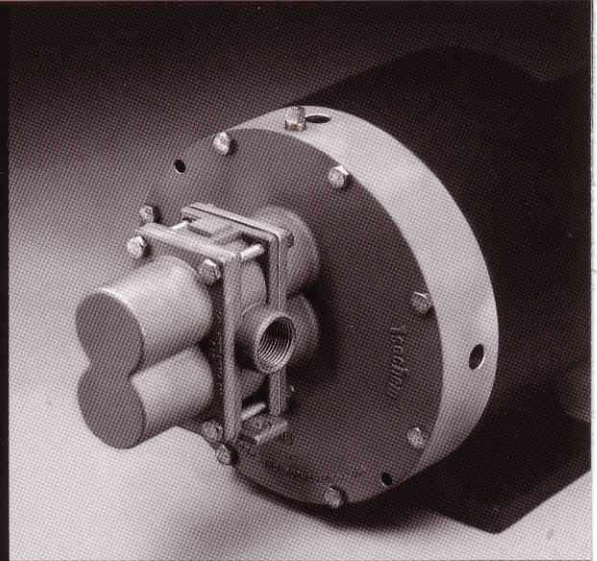

GMH8

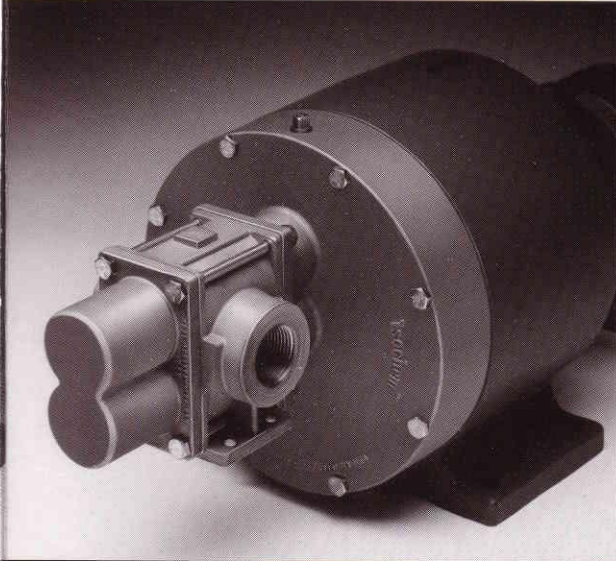

GM12

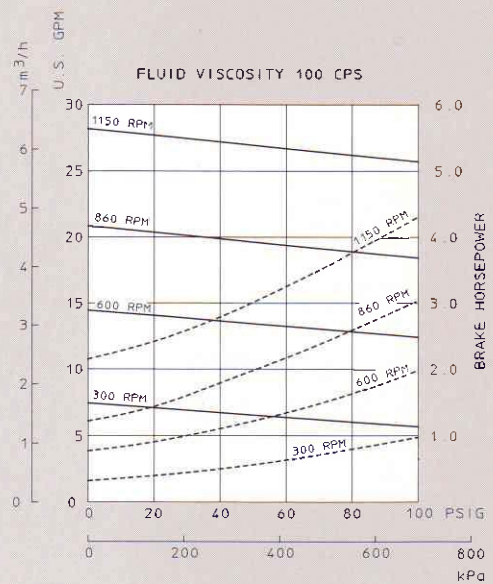
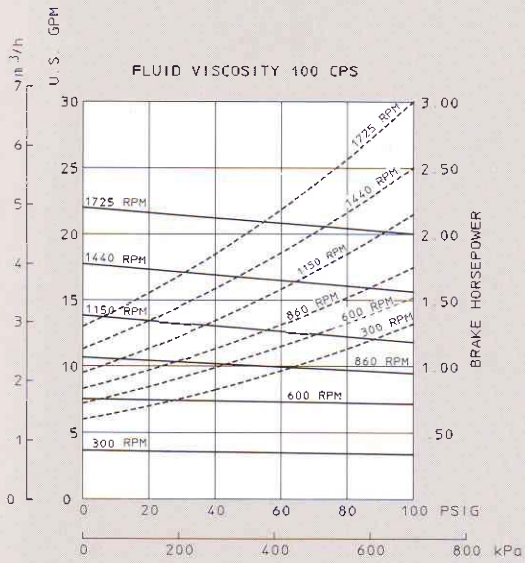
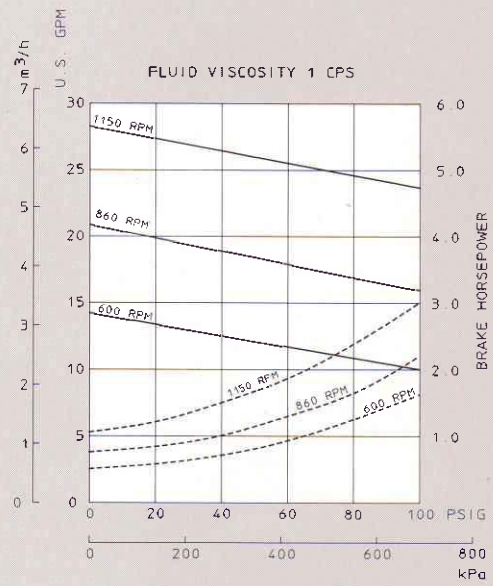
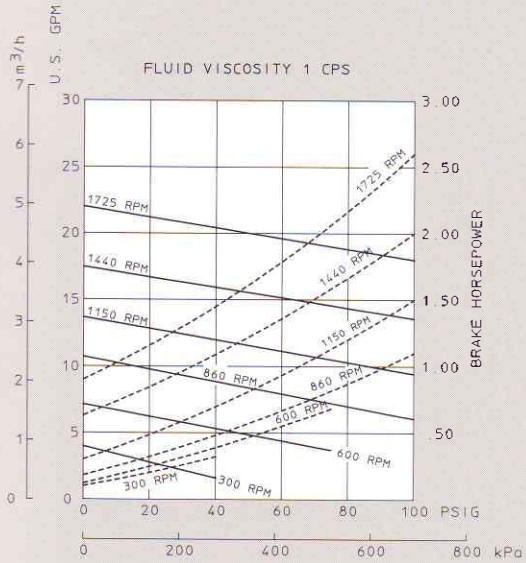
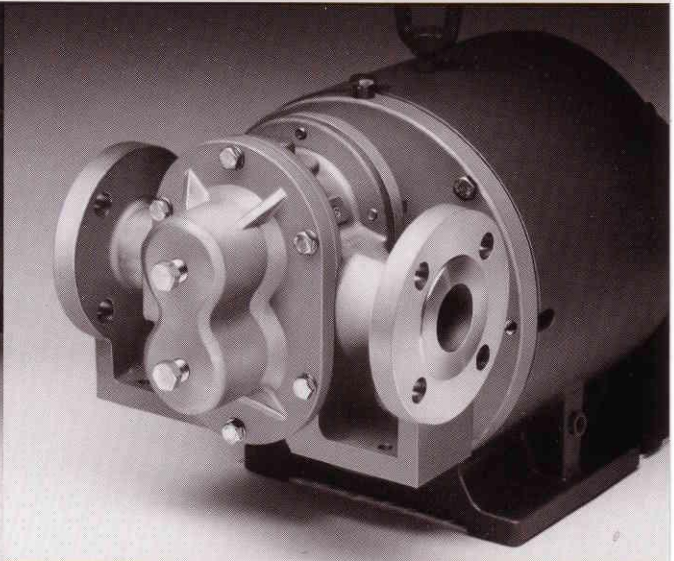

Isochem Gear Pump Options.

In addition to the many standard features offered on the Isochem gear pumps; the following options are also available:

- Silicon carbide bearings with hardened shafts provide added life, extended service intervals.
- A pedestal assembly equipped with anti-friction bearings is ideal when specifying a base mount or pulley drive unit, or when a C face motor is not available.

GM16

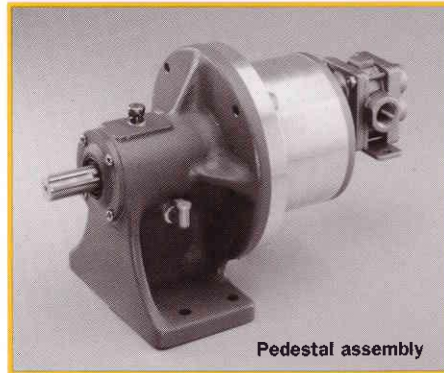
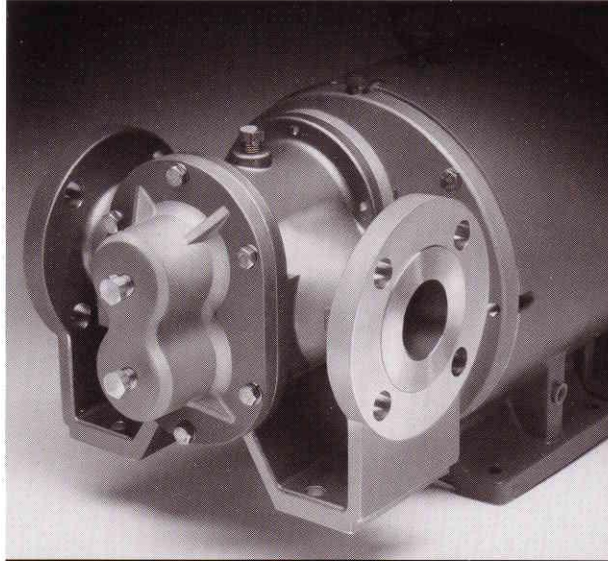

Pedestal assembly

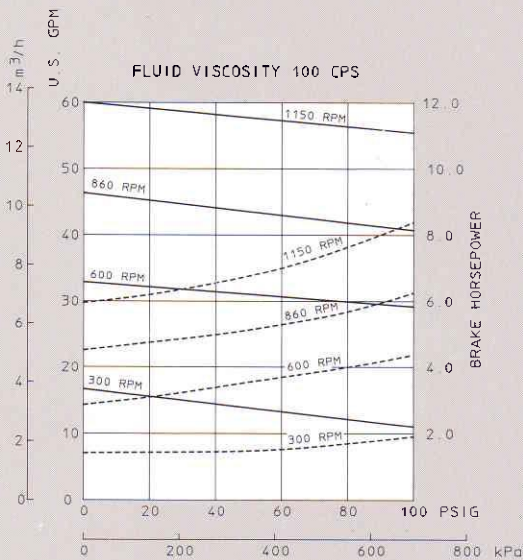
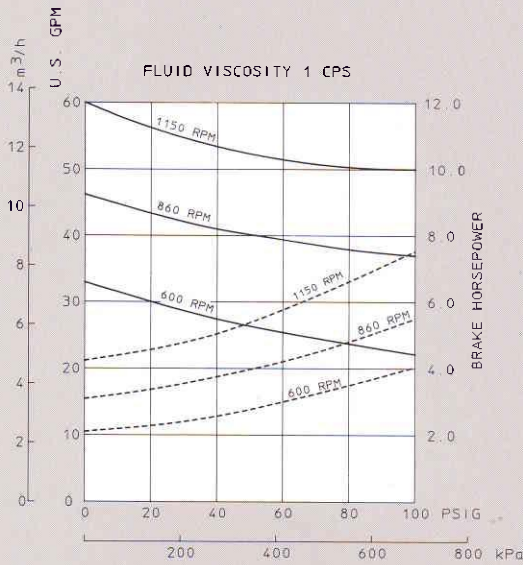

- Bolt-on jackets can enable the user to maintain close control of pumping temperatures. The jackets are designed to conform closely to pump contours to transfer heat evenly. The heating medium may be steam or a heat transfer fluid.

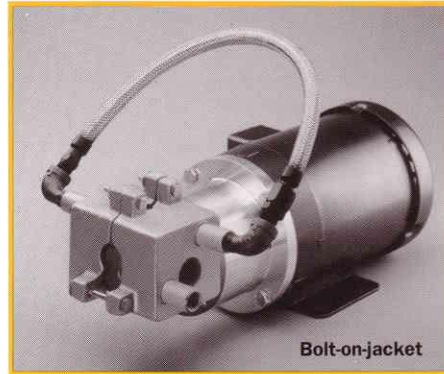

Bolt-on-jacket

- Flanged Ports: Raised-face 150 lb. ANSI flanges are available on the suction and discharge ports of the GH12 and GM16 models.

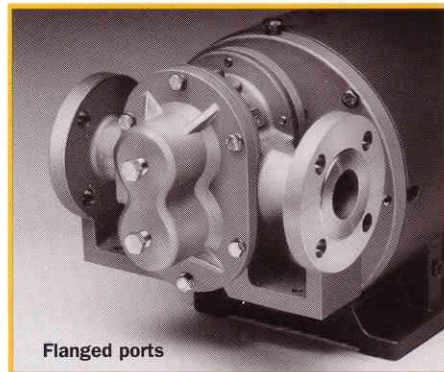

Flanged ports

Consult your local representative for options to meet your special requirements.

How To Select The Right Pump.

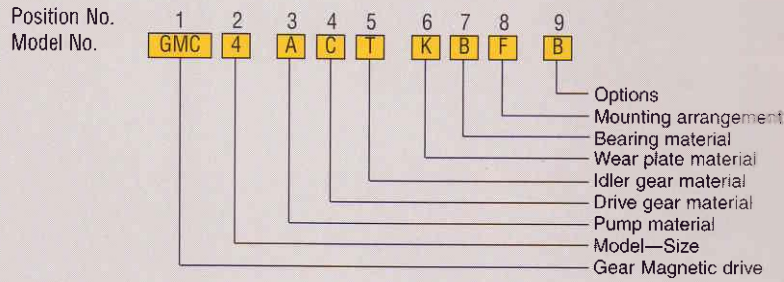
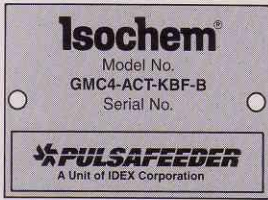

All Isochem pump identification plates include the basic model number. These numbers fully describe the pump specifications necessary for the future identification of your pump, and the replacement of parts or equipment, as needed.

Look at the sample model number (above) to see what information these numbers contain.

Note: Be sure to provide complete nameplate data when you order spare parts or replacement pump-motor assemblies.

Position 1 Isochem® Magnetically Driven Sealless									
GMC = C-Face Motor Mounting Assembly	-2, 4, 6, 8								
GM = C-Face Motor Mounting Assembly	-12, 16								
GMH = Higher Pressure Model, C-Face Motor Mounting Assembly*	-6, 8								
Position 2 Pump Size									
Port Size (inches)	2	4	6	8	*6	*8	12	16	
Capacity (GPM MAX)	.25"	.50"	.75"	1.00"	.75"	1.00"	1.50"	2.00"	
Differential Pres. (PSIG MAX)	100	100	100	50	200	100	100	100	
Position 3 Available Pump Metallurgies and Type Port Connection									
A = 316SS	FNPT	x	x	x	x	x	x	x	
C = ALLOY C	FNPT	x	x	x	x	x	x	x	
D = ALLOY 20	FNPT	x	x	x	x	x	x	x	
K = 316SS	FBSPT	x	x	x	x	x	x	x	
M = ALLOY C	FBSPT	x	x	x	x	x	x	x	
N = ALLOY 20	FBSPT	x	x	x	x	x	x	x	
U = 316SS	Flanged								x
V = ALLOY C	Flanged								x
W = ALLOY 20	Flanged								x
Position 4 Drive Gear Material									
C = ALLOY C		x	x	x	x	x	x	x	x
D = ALLOY 20		x	x	x	x				
T = TFE (GLASS FILLED)	(1)	x	x	x	x				
E = PEEK	(1)	x	x	x	x				
Position 5 Idler Gear Material									
C = ALLOY C	(2, 12)	x	x	x	x	x	x	x	x
D = ALLOY 20	(2)	x	x	x	x				
K = CARBON		x	x	x	x		x	x	x
T = TFE (GLASS FILLED)		x	x	x	x		x	x	x
E = PEEK		x	x	x	x	x	x	x	x
Position 6 Wear Plate Material									
K = CARBON		x	x	x	x	x	x	x	x
T = TFE (GLASS FILLED)		x	x	x	x	x	x	x	x
Z = CERAMIC	(3)	x	x	x	x	x	x	x	x
E = PEEK		x	x	x	x	x	x	x	x
Position 7 Bearing and Shaft Material									
K = Standard Carbon	(4)	x	x	x	x	x	x	x	x
L = Extended Life Carbon	(4)	x	x	x	x	x	x	x	x
T = TFE (Glass Filled)	(4, 11)	x	x	x	x		x	x	x
4 = Standard Carbon - Slotted	(4)							x	x
C = Extended Life Carbon - "CW"	(5)	x	x	x	x	x	x	x	x
B = Silicon Carbide - "CW" Shaft	(5, 6)	x	x	x	x	x	x	x	x
Position 8 Mag Drive Mounting Arrangement									
STANDARD US MOUNTINGS									
F = 56C Frame, SGL. Can Cntnmnt	(13)	x	x	x	x				
O = 143TC- 184C frame, SGL. Can Cntnmnt	(13)	x	x	x	x	x	x		
D = 143TC- 184C frame, DBL.. Can Cntnmnt	(13)					x	x		
R = Ø1.125 Input shaft, SGL. Can Cntnmnt	(14)							x	x
T = Ø1.125 Input shaft, DBL. Can Cntnmnt	(14)							x	x
STANDARD METRIC MOUNTINGS									
J = 71 frame, SGL. CAN (Ø 85.00 B.C.)	(13)	x	x						
K = 80 frame, SGL. CAN (Ø100.00 B.C.)	(13)	x	x						
L = 90 frame, SGL. CAN (Ø115.00 B.C.)	(13)			x	x				
P = 100 frame, SGL. CAN (Ø130.00 B.C.)	(13)								
Q = 100 frame, DBL. CAN (Ø130.00 B.C.)	(13)					x	x		
U = 28mm input shaft, SGL. CAN cntnmnt	(14)					x	x		
V = 28mm input shaft, DBL. CAN cntnmnt	(14)							x	x
Position 9, 10, and 11 options consult your local representative for options to meet your special requirements									

- Notes:**
- (1) Maximum differential pressure for plastic/plastic gears is 50 PSIG.
 - (2) Pumps with metallic drive and idler gears require minimum viscosity of 100 cps and are limited to 1440 RPM maximum speed for GMC2-GMH8 and 1150 RPM for GM12-16 pumps.
 - (3) Ceramic wear plates with metallic gears require minimum viscosity of 100 cps.
 - (4) Shaft material is same as material of pump.
 - (5) "CW" means corrosion/wear shaft material.
 - (6) Recommended for speeds above 1150 RPM and viscosities above 1 cps.
GMH8, GM12/16 pumps require minimum viscosity of 100 cps.
 - (11) GM12 TFE bearings can not be used above 100 psi differential pressure.
GM16 TFE bearings can not be used above 50 psi differential pressure.
 - (12) GM12 pumps with metal idler gear can be operated at 150 psi differential pressure.
 - (13) GMC2, GMC4, GMC6, and GMC8 pumps require motors with feet.
 - (14) GM12, GM16 pumps are not available with integrally mounted motors.
 - (*) High Pressure Model
 - (16) Use "F" in position 8 when using a power frame

Dimensional Data

Model Pump	Pump Dimension In Inches					
	A	B	C	C1	D	F
GM2/GMC2	5.62	.50	1.44	—	.25	7.23
GM4/GMC4	5.62	.50	1.44	—	.50	7.23
GM6/GMC6	6.47	.75	1.66	—	.75	8.69
GM8/GMC8	7.09	.75	2.00	—	1.00	9.94
GMH6	9.12	.75	1.66	—	.75	11.94
GMH8	9.75	.75	2.00	—	1.00	13.19
			2.50	—	1.50 NPT OR BSPT	
GM12	20.33	1.19	—	5.00	1.50-150# RF FLANGE	24.55
GM16	21.33	1.19	—	5.25	2.00-150# RF FLANGE	26.55

GM12 AND 16

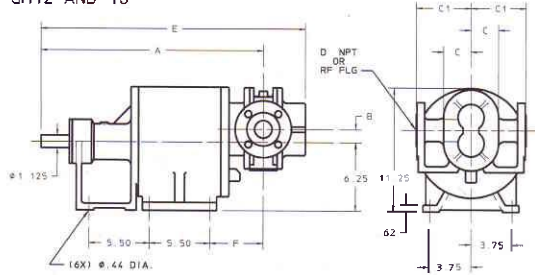

GM2/GMC2 THRU. GM8/GMC8

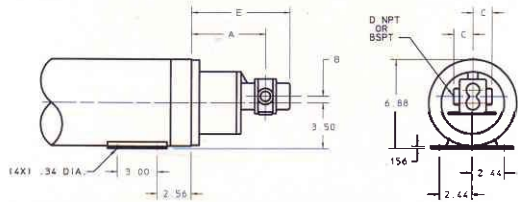

DIMENSIONS SHOWN ARE FOR 56C FRAME MOTORS

GMH6 AND GMH8

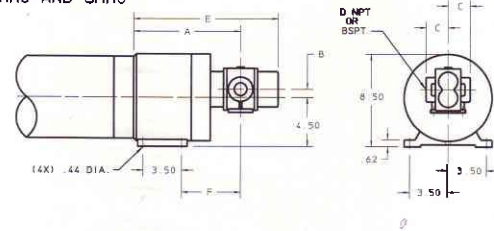

Isochem Express Delivers The Pumps When You Need Them.

Pulsafeeder will give you prompt technical service with off-the-shelf solutions to your pumping needs.

Call your local Isochem representative today for the pumps, parts and service you need.



A Unit of IDEX Corporation

Engineered Pump Operations
2883 Brighton-Henrietta Townline Road
Rochester, New York 14623 USA
Telephone: (585) 292-8000 Fax: (585) 424-5619
<http://www.pulsa.com>
Email: pulsa@idexcorp.com

